

User Manual

PROFIBUS Tester 5 (BC-700-PB)



Version: EN-102024-1.34-1

© Softing Industrial Automation GmbH



Disclaimer of liability

The information contained in these instructions corresponds to the technical status at the time of printing of it and is passed on with the best of our knowledge. The information in these instructions is in no event a basis for warranty claims or contractual agreements concerning the described products, and may especially not be deemed as warranty concerning the quality and durability pursuant to Sec. 443 German Civil Code. We reserve the right to make any alterations or improvements to these instructions without prior notice. The actual design of products may deviate from the information contained in the instructions if technical alterations and product improvements so require.

Trademarks

FOUNDATION™ and HART® are marks of the FieldComm Group of Austin, Texas, USA.
Modbus® is a registered trademark of Schneider Electric, licensed to the Modbus Organization, Inc.

OpenSource

To comply with international software licensing terms, we offer the source files of open source software used in our products. For details see <http://opensource.softing.com/>

If you are interested in our source modifications and sources used, please contact: info@softing.com

Softing Industrial Automation GmbH

Richard-Reitzner-Allee 6
85540 Haar / Germany
<http://industrial.softing.com>

 + 49 89 4 56 56-340

 info.automation@softing.com
support.automation@softing.com

 <https://industrial.softing.com/support/support-form>

Scan the QR code to find the latest documentation on the product web page under Downloads.



Table of Contents

Chapter 1	Introduction.....	7
1.1	About the PROFIBUS Tester 5 (BC-700-PB).....	7
1.2	About this document.....	7
1.2.1	Purpose	7
1.2.2	Target group	7
1.2.3	Conventions used	8
1.2.4	Document history	9
1.3	Scope of delivery.....	10
1.4	Optional accessories.....	11
1.4.1	D-sub adapter cable for testing live systems	11
1.4.2	Adapter Set for M12 Connection Technology	11
1.4.3	Leakage current clamp	11
1.4.4	Adapter for testing PROFIBUS PA networks	12
1.4.5	Spare battery	13
1.4.6	Service interfaces for PROFIBUS DP	13
1.4.6.1	Connection type D-sub.....	13
1.4.6.2	Connection type M12.....	14
1.5	System requirements.....	14
1.6	Connectors and controls.....	15
Chapter 2	Power up and down the device.....	16
2.1	Power-up.....	16
2.2	Power-on behaviour without USB connection.....	17
2.3	Power-on behaviour when USB connected.....	17
2.4	Power-off and sleep mode.....	19
Chapter 3	Connection to PROFIBUS-DP.....	20
3.1	Basics	20
3.1.1	Note when testing a live bus	20
3.1.2	Connection types	20
3.1.3	Adapter cable	20
3.1.4	Strain relief	21
3.1.5	Using the security lock port	21
3.1.6	Test Locations	21

3.2	Simple connection for tests during system shutdown.....	22
3.3	Connection for testing a live bus (DP).....	23
3.3.1	Connection via D-sub connector with service socket	23
3.3.2	Direct cable connection	24
3.3.3	Connection Type M12	25
3.4	Master simulator, topology scan and cable test.....	25
3.5	Connecting to PROFIBUS PA networks.....	27
3.5.1	Requirements for analyzing a live bus	27
3.5.2	PA adapter BC-700-H1 – before you start	27
3.5.3	Connecting PA-adapter to test device	28
3.5.4	Bus connection	29
3.5.5	Test Locations	30
3.5.6	Analyzing during shutdown	31
Chapter 4	Display and control in stand-alone mode.....	32
4.1	Start display.....	32
4.2	User interface.....	32
4.3	Operating functions and softkeys.....	34
4.4	Device status.....	34
4.5	Menu functions.....	35
4.6	Organize and store test results.....	39
Chapter 5	Data import into the PC.....	41
Chapter 6	Device management.....	42
6.1	Licenses.....	42
6.1.1	Which license is activated?	42
6.1.2	How to activate a license	42
6.2	Firmware update.....	43
Chapter 7	Maintenance and Servicing.....	44
Chapter 8	Troubleshooting.....	45
Chapter 9	Tips and tricks for cable testing.....	47
9.1	Assessment criteria.....	47
9.2	Cable test - fault indications and remedial measures.....	47
9.3	Metering the cable segment length correctly.....	50
Chapter 10	Quality index compatibility between BC-600-PB and BC-700-PB.....	52
10.1	What does the quality index indicate and how is the index determined?.....	52
10.2	Why might the BC-700-PB display different quality indexes?.....	52

Chapter 11	Notes on external trigger input and output.....	53
Chapter 12	Notes on battery use.....	54
12.1	General hints and warnings on rechargeable battery use.....	54
12.2	Charge battery.....	55
12.3	Replace battery.....	56
12.4	Discharge battery.....	56
12.5	Storage and transportation.....	56
12.6	Battery lifetime.....	57
12.7	Battery warranty.....	57
12.8	Lithium backup battery.....	57
Chapter 13	Technical Data.....	58
Chapter 14	Declarations by the manufacturer.....	59
Index	61

This page is intentionally left blank.

1 Introduction

1.1 About the PROFIBUS Tester 5 (BC-700-PB)

The PROFIBUS Tester 5 (BC-700-PB) is a powerful tool that allows full testing of the bus physics and bus communication on PROFIBUS DP and PROFIBUS PA segments (option). Using the integrated master simulator, you can also test the bus physics if the PLC is currently not in operation. In addition you can check individually check "suspicious" bus stations. The cable test function examines the cabling in PROFIBUS DP segments. It locates unwanted reflections on the line and verifies proper termination of cable segments. The tool is powered either by its built-in battery or through an external AC adapter.

The PROFIBUS Tester 5 (BC-700-PB) is the first battery-powered tester, which combines the assessment of bus physics and bus communication as well as cable testing in one device. It is therefore the only and truly mobile PROFIBUS diagnostic tool.

1.2 About this document



Read this manual before starting

For damages due to improper connection, implementation or operation Softing refuses any liability according to our existing guarantee obligations.



CAUTION

Refer also to the safety precautions for battery and battery pack in Section [Notes on battery use](#)⁵⁴.

1.2.1 Purpose

This document describes the BC-700-PB. It provides information about putting into service and also provides detailed information regarding its safe and correct operation.

1.2.2 Target group

This document is addressed to operating staff which is adept in operating PROFIBUS-systems such as:

- Maintenance personnel
- Commissioniers
- Application engineers and developpers
- Trainers

1.2.3 Conventions used

The following conventions are used throughout Softing customer documentation:

Keys, buttons, menu items, commands and other elements involving user interaction are set in bold font and menu sequences are separated by an arrow

Open **Start** → **Control Panel** → **Programs**

Buttons from the user interface are enclosed in brackets and set to bold typeface

Press **[Start]** to start the application

Coding samples, file extracts and screen output is set in Courier font type

MaxDlsapAddressSupported=23

Filenames and directories are written in italic

Device description files are located in C:
*\<productname>\delivery\software\Device
Description files*



CAUTION

CAUTION indicates a potentially hazardous situation which, if not avoided, may result in minor or moderate injury.



Note

This symbol is used to call attention to notable information that should be followed during installation, use, or servicing of this device.



Hint

This symbol is used when providing you with helpful user hints.

1.2.4 Document history

Document version	Modifications compared to previous version
1.00	none - initial publication
1.01	<ul style="list-style-type: none"> ▪ Editorial modifications following internal review ▪ Order numbers for optional accessories added ▪ New device status icons added ▪ New cable test note added
1.10	<ul style="list-style-type: none"> ▪ Revised and enhanced PA-specific topics ▪ Internal battery is installed upon delivery - new section "Replace battery" inserted. ▪ Added a recommendation with respect to cable shield ▪ Added reference about Softing License Manager
1.11	<ul style="list-style-type: none"> ▪ New optional accessory ▪ Modified battery descriptions ▪ Document structure optimized
1.20	<ul style="list-style-type: none"> ▪ Note regarding providing device serial number when ordering the PA-H1-Adapter and activating the license ▪ New section describing how to work with the PA-Adapter BC-700-H1
1.30	<ul style="list-style-type: none"> ▪ New test function Locate Stations^[36] ▪ New oscilloscope^[36] functionality in stand-alone mode with result display and without need to use PROFIBUS Diagnostics Suite (requires additional license, refer to Licenses^[42]) ▪ Segments, locations and networks can be created in the PROFIBUS Diagnostics Suite and then be downloaded^[36] to the BC-700-PB (refer also to the PROFIBUS Diagnostics Suite online help for more information)
1.31	<ul style="list-style-type: none"> ▪ Order numbers removed from document. Some additional minor changes.
1.32	<ul style="list-style-type: none"> ▪ Order number changed in Fig 20, Chapter 3.4.
1.33	<ul style="list-style-type: none"> ▪ Spare battery^[13] can no longer be ordered from Softing.
1.34	<ul style="list-style-type: none"> ▪ Updated scope of delivery
1.34-1	<ul style="list-style-type: none"> ▪ Maintenance and servicing^[44] requirements changed to recommendation of 24-month interval.

1.3 Scope of delivery

The BC-700-PB carrying case contains:

- Test tool with RS485 interface.
- Rechargeable battery pack (internal battery).
- Wide-range power supply with European and US mains power cables.
- RS485 D-sub adapter cable ACA-NN-006032 "Standard" (cable petrol blue, light connector) for PROFIBUS DP.
- 2 m USB cable
- Terminal block for trigger input/output
- Carrying case with cut-outs for optional accessories (leakage current clamp, adapter for testing PROFIBUS PA networks, spare rechargeable battery).



Figure 1: BC-700-PB in carrying case

1.4 Optional accessories

1.4.1 D-sub adapter cable for testing live systems

This D-sub adapter cable is optimized for reduced influence on live PROFIBUS DP segment operation. Thereby it is most suitable for testing of running plants. The risk of critical influences on bus operation which can cause a plant standstill is significantly reduced.



Note

Using this cable it is not possible to use both active functions master simulator and topology detection (see [Master simulator and topology scan](#)²⁵).



Figure 2: D-sub adapter cable with reduced influence on bus operation
Softing order number: ACA-NN-006031

1.4.2 Adapter Set for M12 Connection Technology

Using the M12 adapter set, you can connect the PROFIBUS Tester 5 to field devices with M12 connectors. The set comprises an M12 adapter cable with special pin layout and an M12 terminating resistor that you can screw on, if required.



Figure 3: Special adapter set for M12
Softing order number: ACA-NN-006033

1.4.3 Leakage current clamp

When routing PROFIBUS cables in high-interference environments, electromagnetic interference can affect the signal quality. By measuring the shield currents with the digital leakage current clamp, you can locate EMC problem areas and take appropriate countermeasures. The digital leakage current clamp is supplied in a handy case, including measuring cables. There is also an empty compartment for the fieldbus shield digital leakage current clamp in the carrying case of the PROFIBUS Tester 5 (BC-700-PB).



Figure 4: Fieldbus leakage current clamp
Softing order number: DDA-ZZ-004010

1.4.4 Adapter for testing PROFIBUS PA networks

The optional plug-in adapter (including test equipment set) for PROFIBUS PA networks enables the BC-700-PB to analyze electrical signal quality and data communication in PROFIBUS PA installations. The BC-700-PB in conjunction with the adapter BC-700-H1 is the proper test tool for identifying basic installation errors and defective PROFIBUS PA stations.



License for PA option

If you want to use the PA-Adapter BC-700-H1 with your BC-700-PB you need a corresponding license (upgrade). This license is related to the serial number of your device. When ordering the PA option we kindly ask you to provide us with the serial number of your BC-700-PB (see also [Licenses](#))^[42].



Before using the PA adapter

Before using the PA adapter for the first time read carefully section [PA-Adapter BC-700-H1 – before you start](#)^[27]. Activate the PA license on your device and preform the required updates.



Note

Note the PROFIBUS PA-specific notes in sections [Connecting to PROFIBUS PA-networks](#)^[27], [Display and controls in stand-alone mode](#)^[32] and [Licenses](#)^[42].

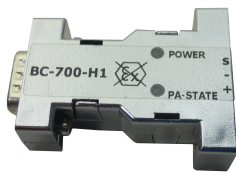

Figure 5: BC-700-H1 adapter



Figure 6: Supplied test equipment set for connecting to PROFIBUS PA segments

Softing order number: DDL-NL-006010

1.4.5 Spare battery

Intensive use of BC-700-PB during the work day may exhaust the rechargeable battery faster than expected. In addition charging and discharging will typically wear out the battery pack over the time (refer to [Notes on battery use](#)^[54]). BC-700-PB has an internal energy management. If the measures for energy saving are not sufficient or are perceived as a disturbance it is recommended operating on the device in conjunction with an external power supply. Each unit comes with a rechargeable battery of type PA-L27.K02 which can be ordered from any vendor and replaced if required.



Figure 7: Rechargeable battery pack

1.4.6 Service interfaces for PROFIBUS DP

1.4.6.1 Connection type D-sub

The D-sub service interface provides a PROFIBUS access point for testing if the existing D-sub connectors have no service socket or if the bus stations are connected via a terminal block. The service interface can power the terminating resistor of the D-sub connector. You can thus use it as an active bus termination at the beginning or end of the bus.

If the PLC allows dropping and adding bus stations on the live bus, you will need this external bus termination to be able to exchange the first and last bus stations without causing problems on the bus.

The compact unit is rail mounted like a terminal block and powered by an external 24 VDC power supply. The package includes an 90° angled PROFIBUS connector with a switchable terminating resistor.

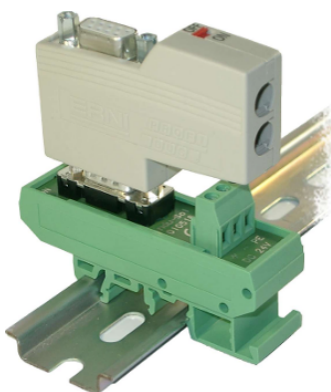

Figure 8: D-sub service interface for testing a live bus

Softing order number: ACA-NN-006037

1.4.6.2 Connection type M12

The M12 service interface comprises an IP68 rated T piece, an end cap for the service output of the T piece, and a 1m PROFIBUS DP cable fitted with a male/female M12 connector on each end.



Figure 9: M12 service interface

Softing order number: ACA-NN-006034

1.5 System requirements

Hardware

- PC
- USB 2.0 Port

Operating system

- Windows 7, Windows 8, Windows 8.1 and Windows 10 (each in 32 bit and 64 bit version)

1.6 Connectors and controls



Figure 10: Connectors, buttons and status displays on the BC-700-PB

2 Power up and down the device



Install PROFIBUS Diagnostics Suite before connecting to a PC

Before connecting the BC-700-PB for the first time with a PC make sure the latest PROFIBUS Diagnostics Suite and the required drivers are installed on your PC. For detailed installation instructions refer to the Quick Startup Guide supplied with your PROFIBUS Diagnostics Suite CD-ROM.



Always connect device directly to an USB port

Use the included USB cable to connect the tool to a PC or notebook. When you use external USB hubs, notebook docking stations or USB 3.0 ports for connection, problems may occur.

2.1 Power-up





1. Acclimate to room temperature

Before being connected to the AC mains power, the PROFIBUS Tester and the AC adapter must be acclimated to room temperature to avoid condensation. This may take up to 60 minutes.

2. Power-up

Make sure that you have either connected it to a power supply, or that you have inserted the battery. Then switch on the tool by pressing the power key at the upper front edge. The display lights up and self-test starts.

3. Check battery charge level

The display shows the [battery charge level indicator](#)  ( ,  , ). If the charge level is too low, recharge the battery as described in [Charge battery](#).



Hint

We recommend operating the device solely using the wide-range power supply supplied or using the integrated battery to avoid equalizing currents which can falsify the test results.

The tool is powered by a built-in three cells lithium ion accumulator with 11.1 VDC. Alternatively the tool can be powered by 24 VDC through the external wide-range power supply.

2.2 Power-on behaviour without USB connection

If not connected to an USB port, the BC-700-PB starts up in stand-alone mode (see [Display and controls in stand-alone mode](#)^[32]) and is immediately ready for testing. During program start-up the splash screen is shown for a few seconds and displays "USB NOT CONNECTED":

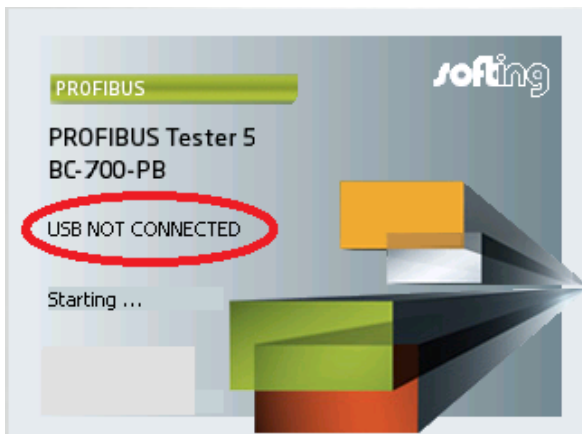

Figure 11: Splash screen – starting without USB connection

2.3 Power-on behaviour when USB connected



Install drivers before connecting to USB

Install the PC software "PROFIBUS Diagnostics Suite" and the corresponding drivers before connecting for the first time to a PC or to a notebook. You will find software and drivers on the PROFIBUS Diagnostics Suite CD-ROM.



The internal battery of BC-700-PB is NOT charged when being connected to a USB port.

On successful completion of the self-test, the BC-700-PB displays:

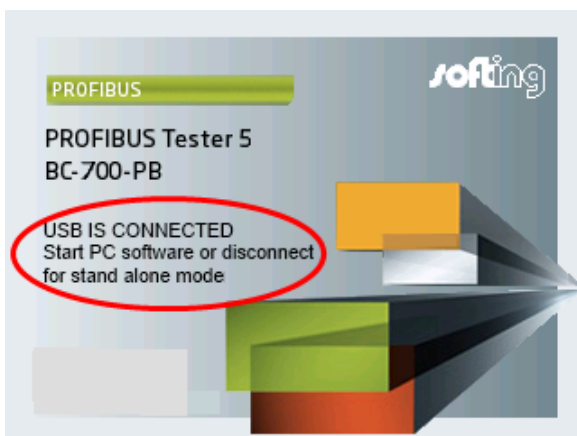

Figure 12: Power-up display when USB connected

When you start the PROFIBUS Diagnostics Suite control and evaluation software on your computer and select the PROFIBUS Tester and a network for testing in its user interface, the test tool switches to PC mode. At this point, a firmware update instead of using the control and evaluation software might be started automatically. See [Firmware update](#)^[43].

The display shows:

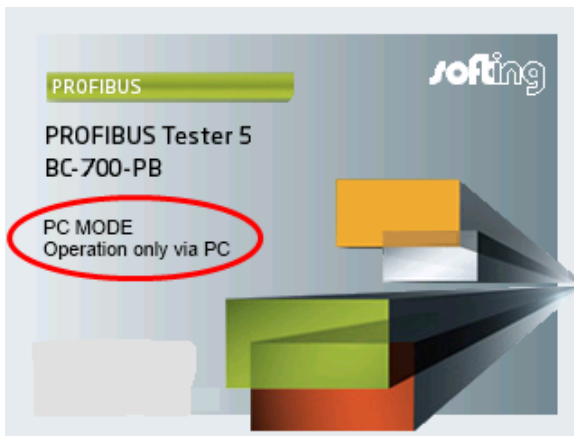

Figure 13: Display during test with PC software



Do not connect/disconnect the USB while the device is booting.

2.4 Power-off and sleep mode

Power-down

Press power key for more than three seconds in order to power-down the device. There is no power consumption if the device is powered down. The device can be stored for long a period of time.

Activate sleep mode

If you want to change manually to sleep mode, shortly actuate the power key. During sleep mode the BC-700-PB is saving energy and the power key will blink slowly. If a measurement function is currently active, it is not possible to switch to sleep mode. Depending on the settings in energy management, the BC-700-PB may automatically change to sleep mode after a predefined period of time.

Return to normal operation mode

You can recover normal operation very quickly by shortly actuating the power key a second time. The lastly shown menu screen will be displayed which was active before changing to sleep mode.

Automatic power-down

If the BC-700-PB is in sleep mode for more than 2 hours, it will automatically power down.

3 Connection to PROFIBUS-DP

3.1 Basics

3.1.1 Note when testing a live bus



Test tool side effects

When you connect a test tool, side effects on the system under test are generally unavoidable. If the PROFIBUS is already disturbed to a certain degree or if Simatic Diagnostic Repeaters are used, the operation of the PROFIBUS might nevertheless be affected occasionally. Observe the following connection notes.

3.1.2 Connection types

There are several ways to connect a bus station to a PROFIBUS network:

- Using connectors
 - [D-sub connectors](#) ²³, most of which have an integrated terminating resistor and, optionally, an additional service socket
 - [M12 connectors](#) ²⁵ for environments requiring increased IP ratings
 - Special vendor-specific hybrid connectors; they are used in combination with special cables to supply power via the bus
- Using terminals for direct connection

Due to the typical daisy-chain topology, the connection points of the bus stations are the only possible points for connecting the test tool in most cases.

3.1.3 Adapter cable

The BC-700-PB is supplied with the D-sub adapter cable ACA-NN-006032 Standard (light connector). For testing on live systems the optional D-sub adapter cable ACA-NN-006031 is recommended. An M12 adapter set is optionally available, see [D-sub adapter cable for testing live systems](#) ¹¹.



Only use original short cables

Use only the original short cables with special pin layout to connect the unit to a PROFIBUS network. Do not cascade more than two D-sub connectors with service sockets at the same time:

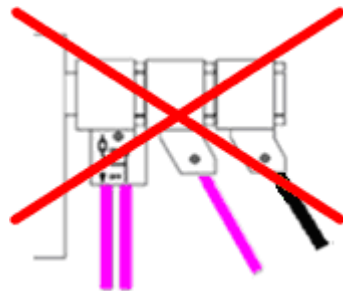

Figure 14: Unallowed cascading of D-sub connectors

3.1.4 Strain relief



Avoid stress on connectors and bus stations

Avoid stress on connectors and bus stations which might be caused by the device's own weight.

Possible measures to avoid stress are

- support,
- strain relief using cable ties or
- using a retaining hand strap. Fastening eyes are premounted at the bottom of the tester. You can fix them either at the bottom or at the top of the tester. The retaining hand strap is not part of the delivery.

If avoiding stress is not possible, you need to select a different connection point to avoid damage.

3.1.5 Using the security lock port

When using trend logging, the BC-700-PB is typically operated in an unattended manner over a prolonged period of time. You can connect a Kensington lock to the security lock port to prevent your device being stolen. The Kensington lock is not part of the product delivery and must be purchased separately. To use the Kensington lock, refer to the product manual. Tie the Kensington lock cable to a fixed object and install the other end of the cable to the security lock port.

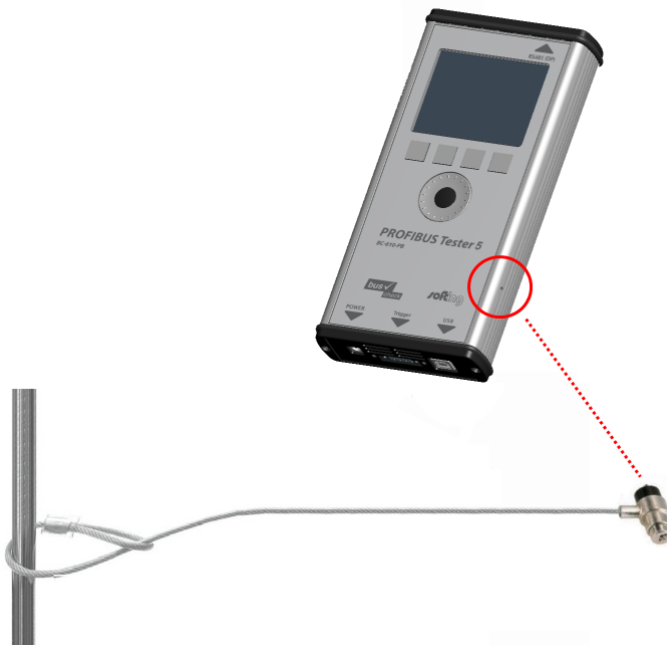

Figure 15: Using a Kensington lock

3.1.6 Test Locations

Basically you can carry out tests anywhere on a physical PROFIBUS segment using the BC-700-PB. Note that the use of repeaters creates separate physical segments that each needs to be measured individually.

For the best and most informative signal quality results, perform the tests at the beginning and end of each physical segment. If these test results indicate problems that cannot be clearly classified immediately, you should carry out one or more additional tests at the center.

3.2 Simple connection for tests during system shutdown

If all bus stations provide D-sub connectors with an additional service socket, you can simply plug in the BC-700-PB at that socket. If a D-sub connector does not provide a service socket, you can plug in the Dsub adapter cable underneath. Keep in mind that you do not cascade more than two D-sub connectors (see [Adapter cable](#) ²⁰).

When using M12 connection technology, the M12 adapter cable is looped into the bus. It is essential to ensure proper termination at the beginning and end of the bus by using the terminating resistor provided with the M12 adapter set.



Shut down complete installation before connecting

All these simple connection types will divide the bus. You therefore need to shut down the PLC and all the devices connected to the PROFIBUS; in other words, you need to shut down the whole installation.

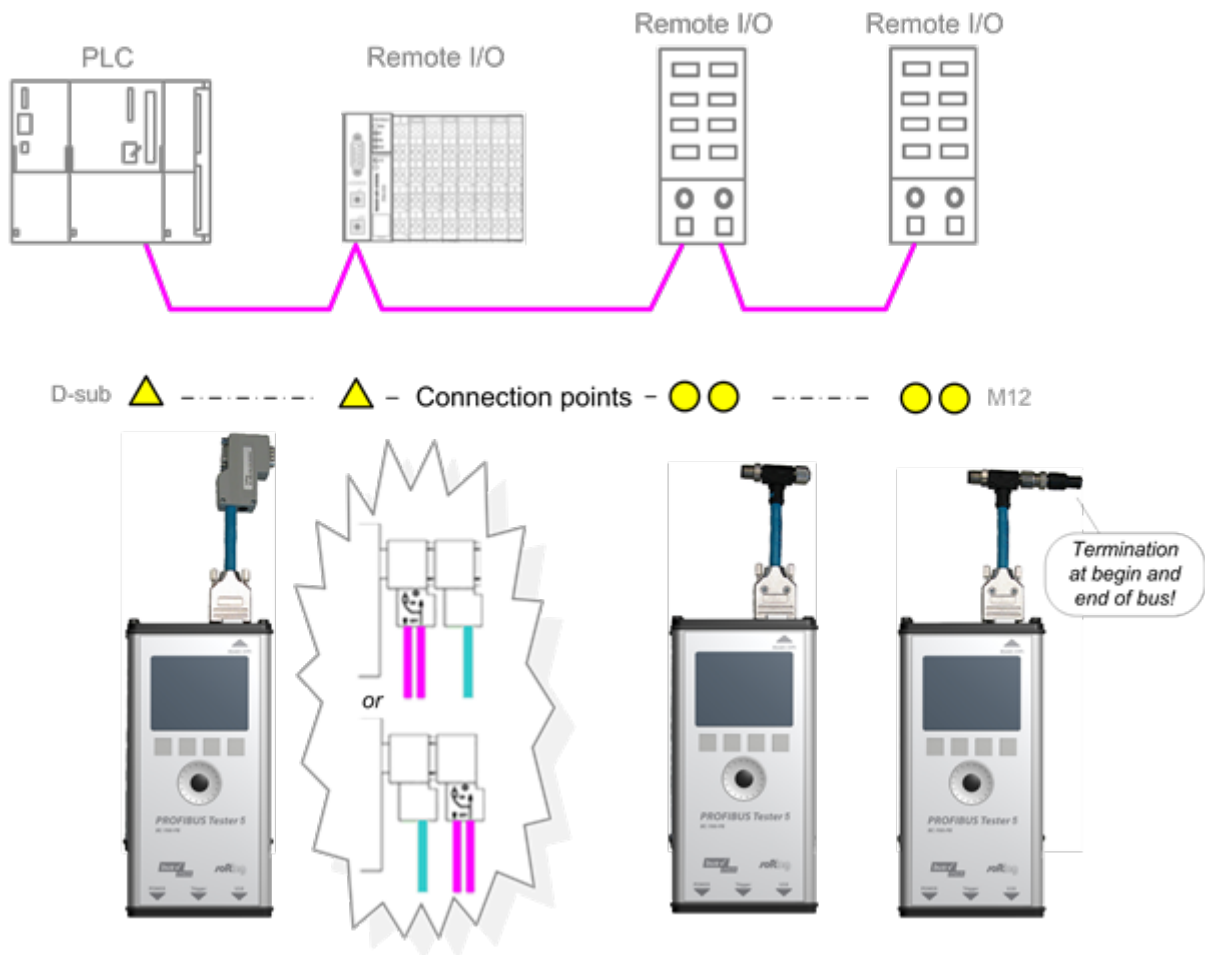

Figure 16: Connection points at system shutdown

3.3 Connection for testing a live bus (DP)

To test a live PROFIBUS with the BC-700-PB during operation, appropriate connection possibilities have to be provided. If no suitable connection points are available in the existing installation, it is recommended installing them during system shutdown. This will make future maintenance work much easier.



Shut down complete installation before connecting

Shut down the PLC and all the devices connected to the PROFIBUS as all these simple connection types will divide the bus.



Use D-sub adapter cable ACA-NN-006031 for testing on live systems

For testing on live systems we highly recommend using the optional D-sub adapter cable ACA-NN-006031 with reduced influence on bus operation. Refer to [D-sub adapter cable for testing live systems](#) ^[11].

3.3.1 Connection via D-sub connector with service socket

If all bus stations provide D-sub connectors with an additional service socket, you can simply plug in the BC-700-PB at that socket.

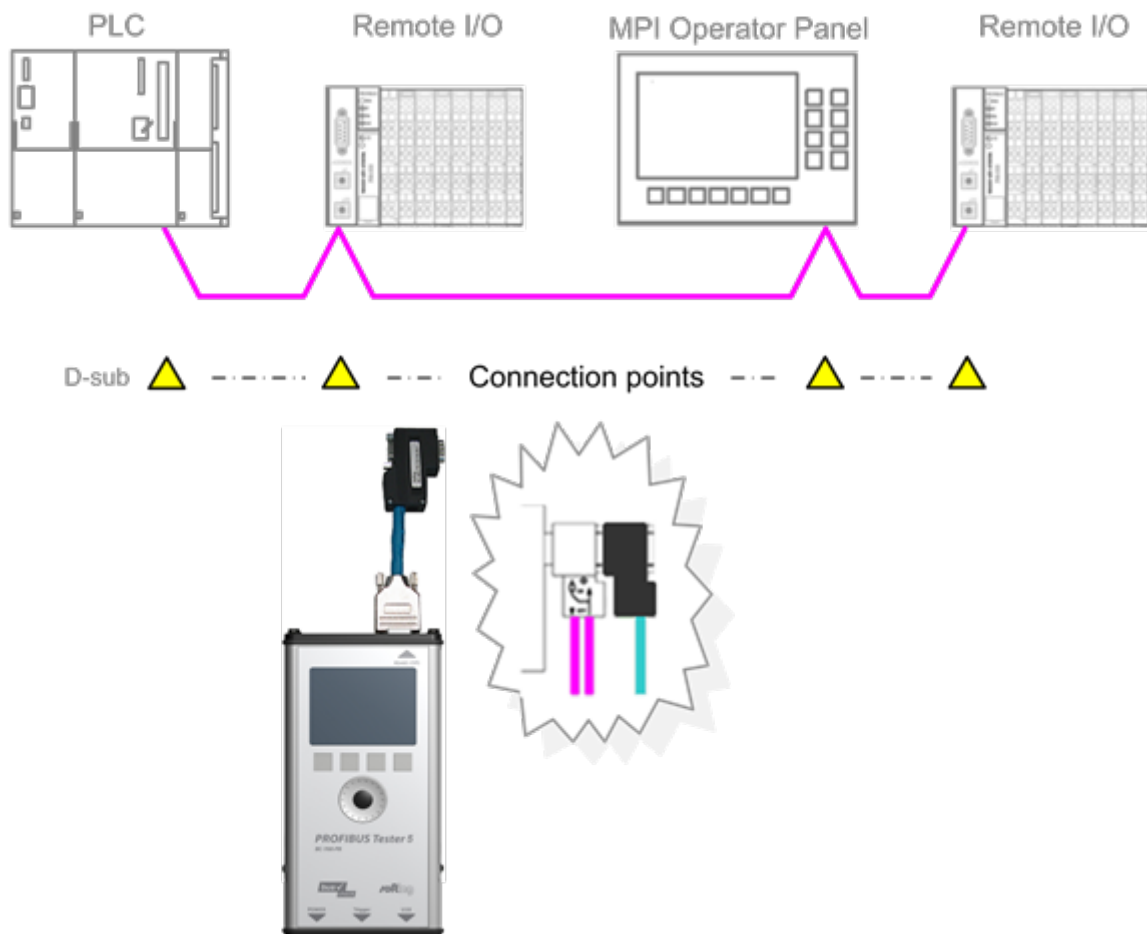

Figure 17: Connection points for the D-sub adapter cable

3.3.2 Direct cable connection

To test a live PROFIBUS, you will need additional D-sub service interfaces of the type BC-PBMB-PB-S (see [Service interfaces for PROFIBUS DP](#)¹³).

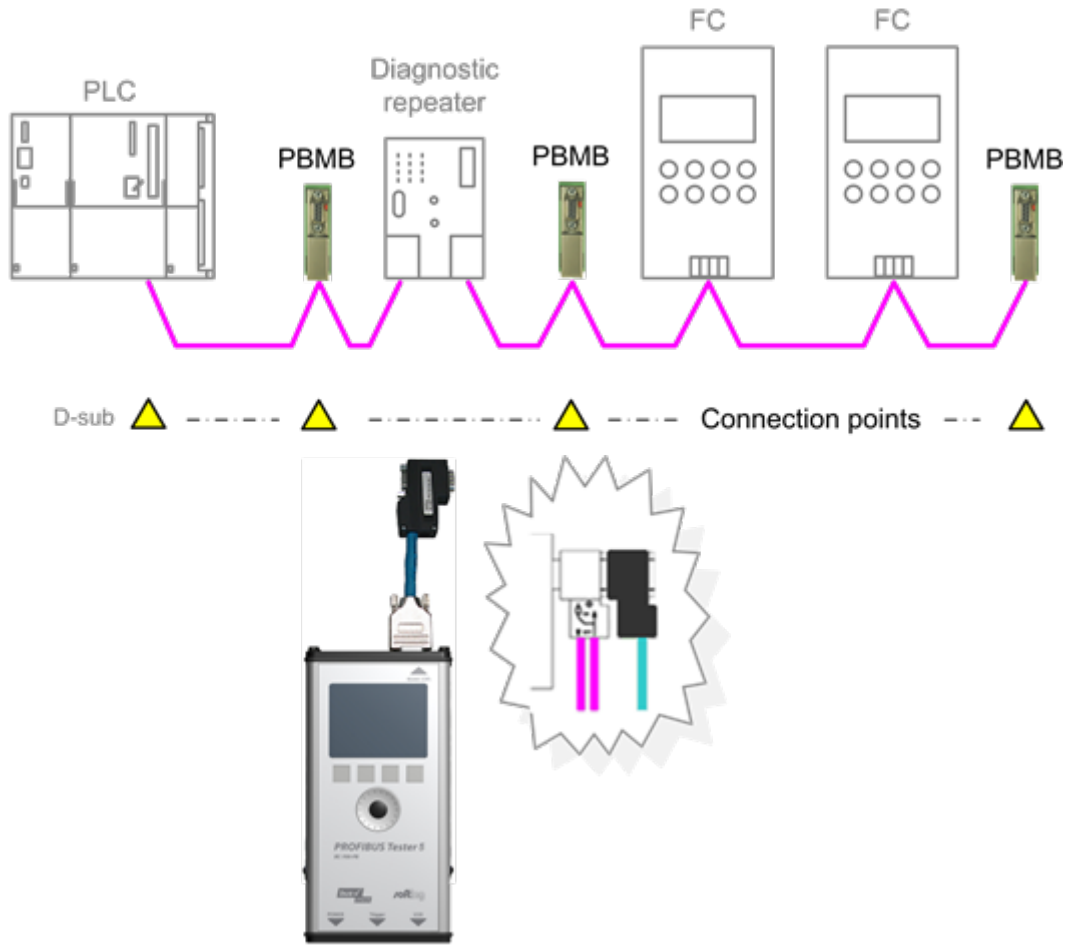

Figure 18: Service interfaces provide connection points at direct cable connection

3.3.3 Connection Type M12

To test a live PROFIBUS, you will need additional service interface of the type BC-M12DP-PB (see [Adapter set for M12 connection technology](#)^[11]).

Tests on a live PROFIBUS are only allowed on bus segments providing D-sub connection technology. Only D-sub connectors with service socket can be used as connection points for the test tool. For this reason, tests can often only be performed at a bus end.

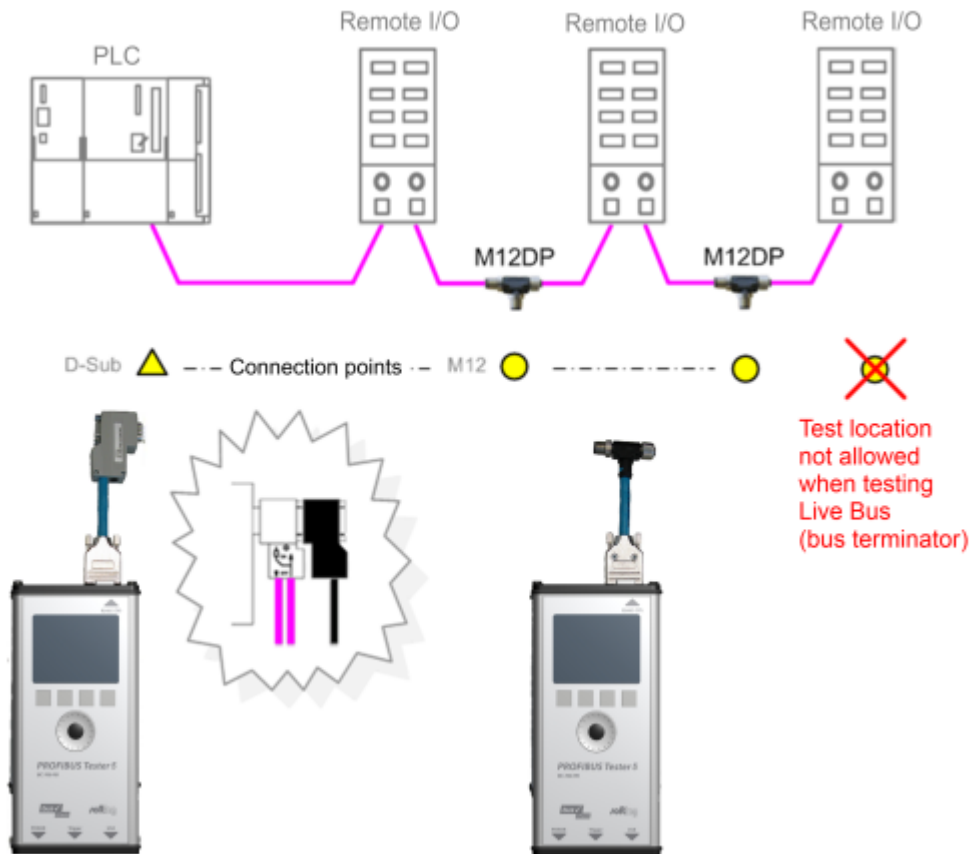

Figure 19: Connection points for the M12 adapter cable



Connect T-fitting between existing cable and 1 meter connection cable

Always connect one end of the T-fitting to the already existing cable and the other end to the 1 meter connection cable which is supplied with the service interface.

Do not screw the T-fitting of the M12 service interface directly onto a slave.

3.4 Master simulator, topology scan and cable test

Master simulator

The master simulator allows checking the bus cabling and the station addresses during installation and commissioning, when the PLC (master) is not in operation yet. In addition, you can use this mode to check individual suspicious bus stations that have been disconnected from the bus.

Topology scan

The topology scan determines the sequence and distances of all passive bus stations (slaves). This feature requires correct bus cabling, a very good signal quality, and a connection point located directly at the beginning or end of the bus.

Cable test

The cable test assesses the wiring and can be used to determine a faulty cable location (e.g. short circuit) by means of reflection test. All three features can only be used during shutdown of the installation. The D-sub cable ACA-NN-006032 which is included in the standard scope of supply must be used. As long as communication is detected on the bus, i.e. at least one device is an active master, the functions are disabled. Check If necessary, disconnect every single active device (PLC, MPI and, if necessary, diagnostic repeaters) from the power supply or the bus. If an active device is at the end of the bus you want to test, its PROFIBUS connector needs to be unplugged and connected directly to the PROFIBUS Tester 5 (BC-700-PB). The bus termination in the device connector will then be powered by the BC-700-PB.

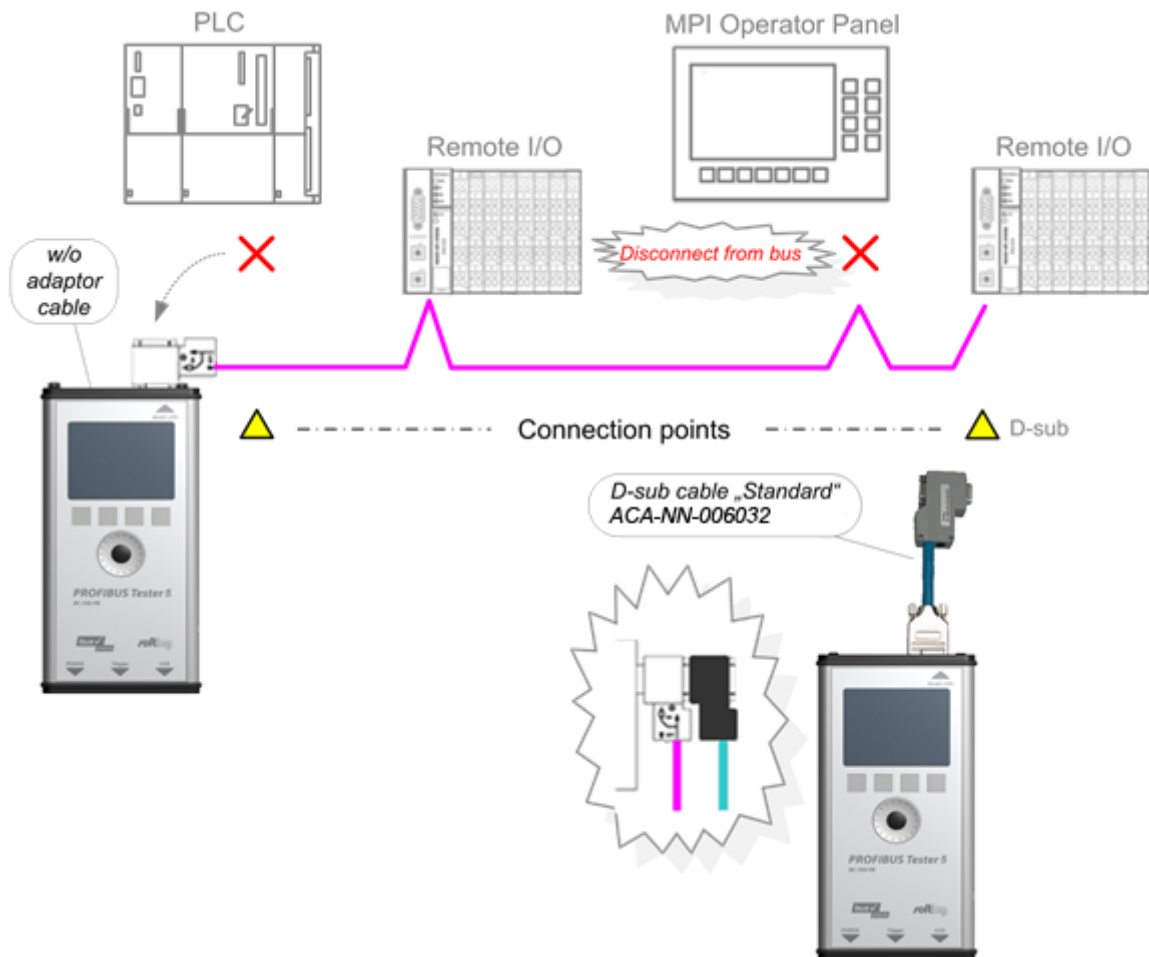

Figure 20: Connection points for topology scan and cable test



Bus stations must only be disconnected from the power supply or the bus during shutdown of the installation.



The three functions can be started also when the BC-700-PB is disconnected from the bus. If you then connect the BC-700-PB to a live bus despite the yellow bus status bar indicated by the PC software, this can cause bus communication problems or a shutdown of the installation.

Special case: active devices at both ends o the bus during topology scan

On the very rare occasion when there is an active device at each end of the bus, do the following:

1. When using D-sub connection:
 - a. Additionally switch on the terminating resistor in the D-sub connector of the last slave.
 - b. Make sure the outgoing cable to the active device at the bus end is connected to the outgoing connector (marked with "OUT", an outgoing arrow, or "A2/B2").

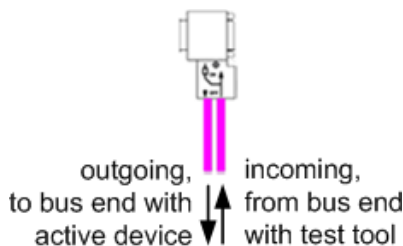

Figure 21: Checking the connection direction at the D-sub connector - topology scan only

2. When using M12 connection:
 - a. Connect the cable from the bus start or test tool to the incoming M12 connector of the last slave.
 - b. A bus termination is required at the outgoing M12 connector of the last slave.

3.5 Connecting to PROFIBUS PA networks

3.5.1 Requirements for analyzing a live bus

When using the BC-700-PB and the BC-700-H1 adapter to carry out measurements on an MBP segment during operation, it is preferable to connect the tool via free bus connection terminals of the DP/PA fieldbus coupler. If the bus begins at the coupler, you can simply use the second terminal block at the DP/PA coupler or at the SK1 or SK2 to sample the bus signal. If the couplers mentioned above are not located at the beginning of the bus or if the bus begins with an SG3 coupler or if you are interested in the PROFIBUS PA signal at another test location, we recommend connecting a short spur cable to rail mounted terminals during system shutdown. This gives you an appropriate connection point and makes future maintenance work much easier.

3.5.2 PA adapter BC-700-H1 – before you start

Before using the PA adapter BC-700-H1 with the BC-700-PB for the first time make sure the following preconditions are fulfilled:

- PROFIBUS Diagnostics Suite version 3.11 or higher is installed on your PC.
- The PA option on the BC-700-PB is activated (refer to [Which license is activated?](#))⁴².
- Firmware version on your BC-700-PB is 01.01.02.00 or higher.

3.5.3 Connecting PA-adapter to test device

Mounting

Precondition: You have disconnected and removed all cables that were connected to the 9-pin D-sub connector of the PROFIBUS Tester before.

1. First connect the 9-pin D-sub connector of the PROFIBUS PA adapter directly to the 9-pin D-sub connector of the PROFIBUS Tester.
2. Then screw the PROFIBUS PA adapter to the BC-700-PB by using the two screws from the D-sub connector.
3. Then connect the PROFIBUS PA adapter with the PA bus.

It is possible to stow the BC-700-PB together with the mounted PA-adapter in the carrying case after use.

Disassembly

Disassemble the PA adapter as described above but in reverse order.

Please note also the PROFIBUS PA-specific information in section [Display and controls in stand-alone mode](#) ³².



Stop running tests prior to mounting or disassembling the PA-adapter

To prevent loss of test data and in terms of a structured mode of operation you should solely mount or disassemble the PROFIBUS PA-adapter BC-700-H1 when there is no running test function.

Two light emitting diodes directly give a check-back indication with respect to the operational state of the PA-adapter and to the DC voltage (supply voltage), see figure.

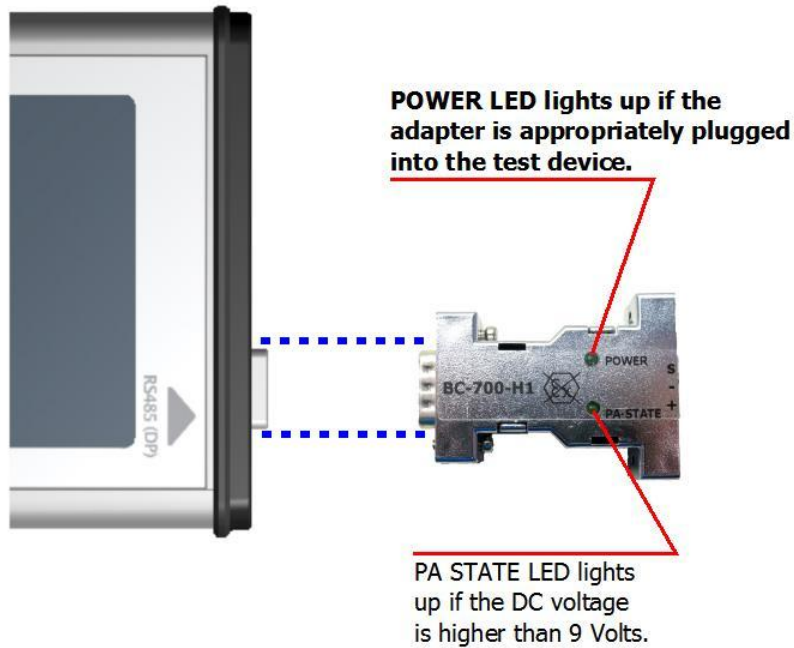

Figure 22: Connecting PA-adapter to test device

3.5.4 Bus connection

The supplied test equipment set allows to easily connect the BC-700-H1 adapter to the PROFIBUS PA segment. Alternatively you can use a short length of PROFIBUS PA standard cable to connect the tool to the bus.



In general it is sufficient to use PA+ and PA-

Protocol analysis, testing DC voltage level (supply voltage) and AC signal levels (MPB peak-peak voltage) require only a proper connection to signal wires PA+ and PA-. To guard against and prevent errors in test and parasitic coupling (EMC) it is additionally recommended using cable shielding or interconnecting the shield connector.

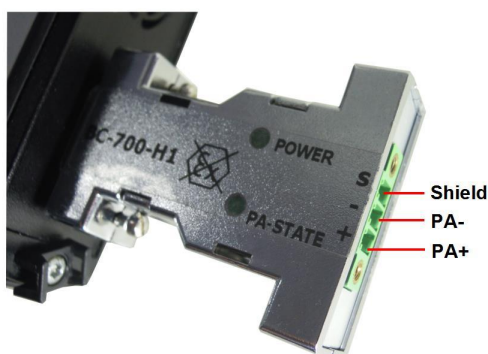

Figure 23: PROFIBUS-PA pin assignment



Do not use in hazardous areas

The BC-700-PB and BC-700-H1 adapter must not be used in hazardous areas and must not be connected to an intrinsically safe MBP-IS segment (blue terminals of fieldbus coupler; in some cases blue bus cables).

3.5.5 Test Locations

There are several ways to connect bus stations to PROFIBUS PA:

- Using terminals for direct connection
- Using M12 connectors in the field (unfortunately there is no rule defining on which sides the male and female connectors are to be used)

Field distributors and T pieces are widely used. As opposed to PROFIBUS DP, spur cables are allowed to a limited extent for PROFIBUS PA.

The following types of DP/PA fieldbus couplers are the most common:

- Simatic DP/PA couplers from Siemens, also as part of DP/PA links
- SK1, SK2 and SK3 segment couplers, e.g. from Pepperl+Fuchs (or sometimes under a different label)

Irrespective of the connection types used for the field devices, the fieldbus couplers are usually installed in a control cabinet, and the PA output is connected there via terminals.



Connection to MBP-IS is not allowed.

You can use the connection points of bus stations or access points inside the field distributors as connection points. Establishing the electrical connections required for measuring may vary from system to system and might not be possible during operation.

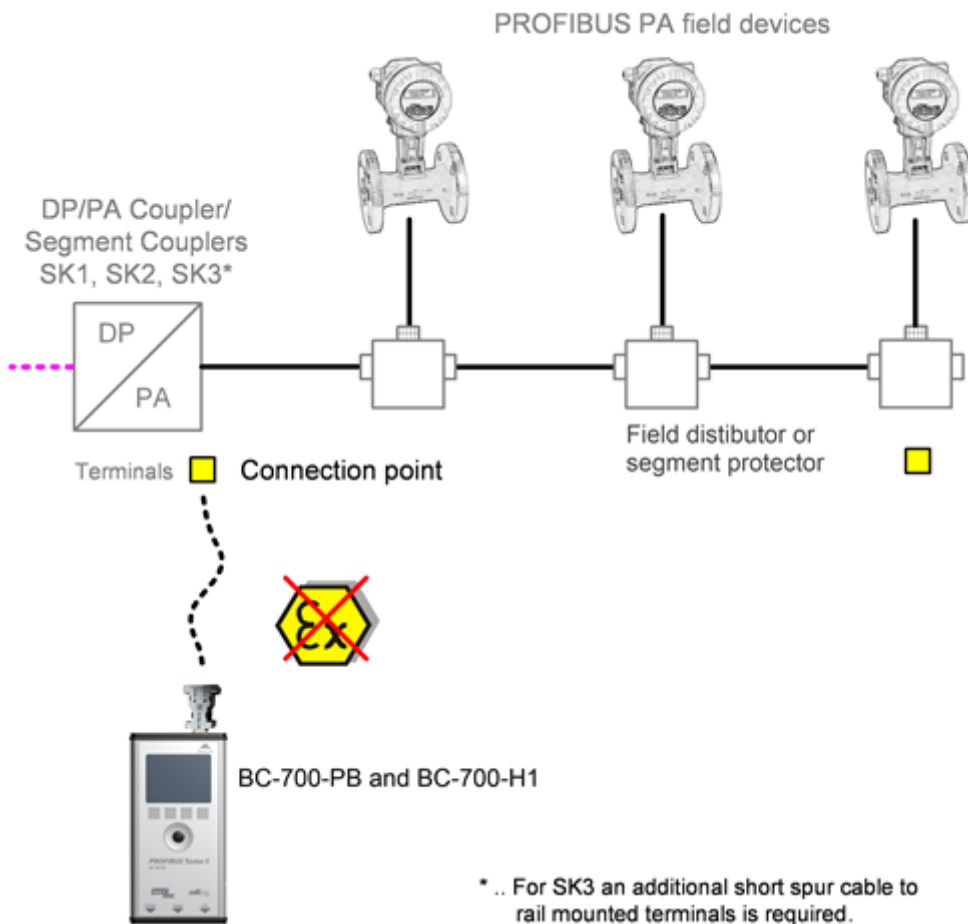

Figure 24: Connection points for PROFIBUS PA

**Hint**

An appropriate connection point is located directly at the DP/PA coupler. At this point, the tool can continue to analyze the bus communication even when lines are interrupted. The measurements are not affected by repeaters or field barriers.

3.5.6 Analyzing during shutdown

If there is no possibility for connection, you need to improvise in order to pick up the bus signal at an existing terminal block of the fieldbus coupler, the field distributor, segment protector or a field device. For example, you can try a double assignment of bus terminals.



Shut down the system before you divide the bus.

Disconnect all bus stations from the power supply.

4 Display and control in stand-alone mode

The BC-700-PB always starts in stand-alone mode unless it is USB connected to a PC or notebook. The readings are shown on the graphical display. You can control the tool with the four softkeys, the scroll wheel and the push button in center of the scroll wheel (see [Connectors and controls](#)^[15]).

When you establish a USB connection during stand-alone mode while a test is running, the test will be aborted and the tool will be reset (restart). The display briefly shows: "Switching to PC mode".

4.1 Start display

The start display appears after start-up in stand-alone mode (or when all dialogs or functions have been stopped and you have been returned to the main menu). The start display (with main menu) is your starting point where you can open any of the test functions or additional administrative functions.

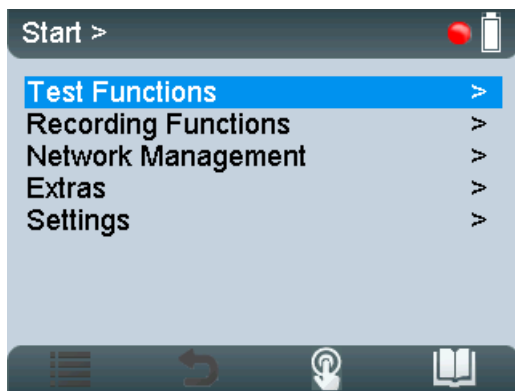

Figure 25: Start display

4.2 User interface

The user interface of BC-700-PB comprises four parts:

- **Device Status**
The device status in the upper right corner provides information such as the battery charge level indicator, system load status, memory information, state of master simulator, connected interfaces and adapters,...
- **Application status**
The application status at the upper edge on the left displays which function or sub-function is currently selected.
- **Workspace**
The Workspace in the center of the graphical user interface contains the start page, detail views for the bus analyzes and views for administrative purposes. At a glance the user views the most important information with respect to the selected test function.
- **Control information**
Control information is shown at the lower edge of the user interface. The meaning of the four softkeys is explained in [Operating functions](#)^[34].

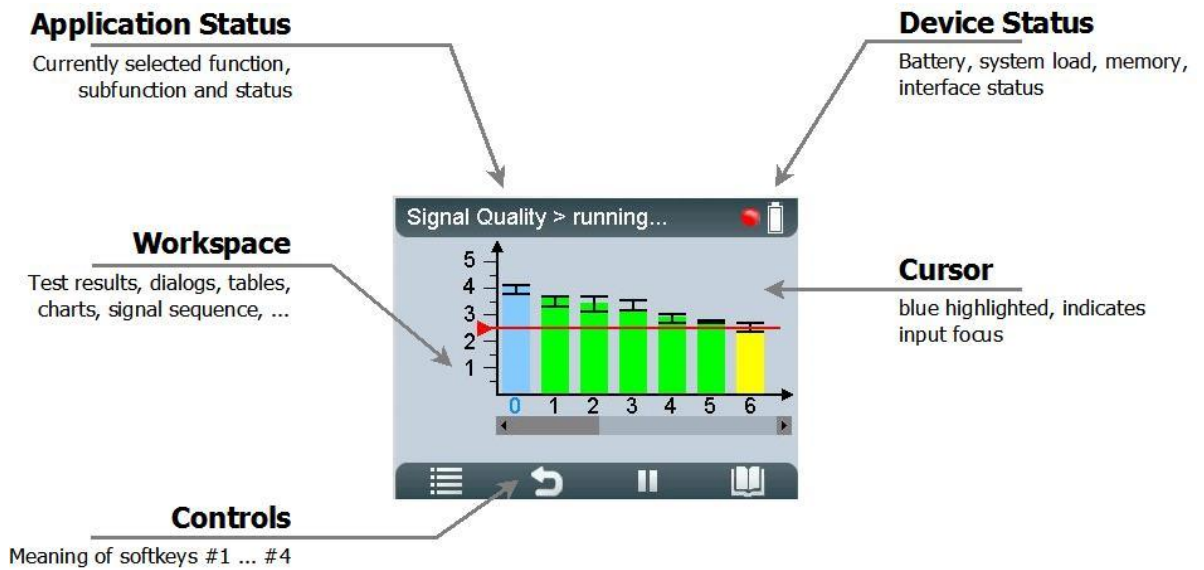

Figure 26: Division of screen areas

The presentation of dialog information uses four layouts:

- Additional information which is typically less important is shown on user request in Info-dialogs. Access to this read-only function or information is subjected to a sub-menu function or to the [Info]-softkey.
- Other functions may require appropriate user input by means of input dialogs. The colors light blue and blue indicate, which elements are selectable or changeable by means of the input focus (cursor).
- Error messages are displayed in error dialogs.
- The BC-700-PB provides a context-sensitive online help. Their content is shown in quick reference dialogs using a smaller font size.

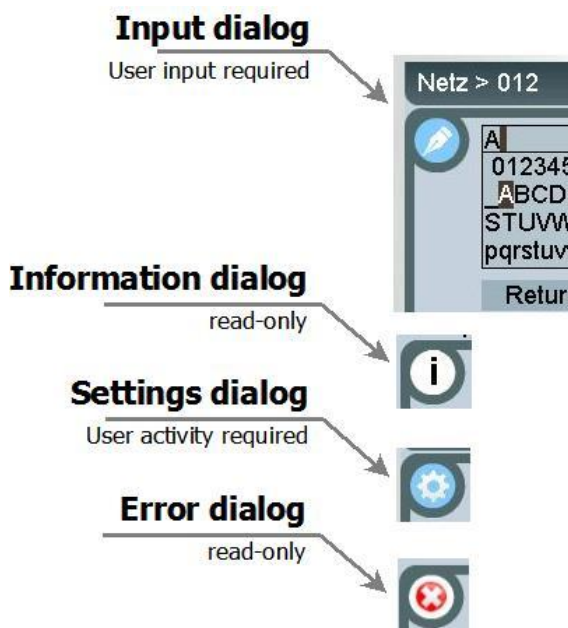

Figure 27: User interface dialogs

4.3 Operating functions and softkeys

Use the scroll wheel, in order to move the cursor within lists, tables, dialogs and alphabetic strings. Selected elements are highlighted in blue. Press the central button of the scroll wheel or press the Selection- or [Info]-softkey in order to call functions or to request additional information. The appearance of controls will change in a context-sensitive manner. If a softkey is grayed out, the corresponding operating function is disabled.

Icon	Function
	Open menu/ submenu
	Browse backwards, quit menu function
	Browse tab to the left
	Browse tab to the right
	Confirm/ select (central button in scroll wheel)
	Start a previously stopped function
	Stop a running function
	Request details for selected elements (press briefly) or Open context-sensitive reference (press button approx. for 2 seconds)
	Open context-sensitive reference

4.4 Device status





The following table contains the meaning of the device status icons. Device status information is available and visible at any time of device operation in stand-alone mode.

Battery charge level (internal battery with/without AC adapter connected)

Icon	Description
	Internal battery charge level (approx. 100 %, 66 %, 33 %)
	Critical battery charge level. BC-700-PB is going to shut down automatically in a couple of minutes. Connect BC-700-PB to the AC adapter.
	AC adapter connected and battery is charging
	Battery completely charged - without AC adapter connected
	Battery completely charged - with AC adapter connected

Icon	Description
	Battery not found or defective. The device runs with external power supply.

Testing and measurement status

Icon	Description
	<p>PROFIBUS DP: There is bus activity. If the LED is green, but no baud rate is displayed (e.g. in Bus Status function), the bus activity results from disturbances and not from regular frames.</p> <p>PROFIBUS PA: There is bus activity (31.25 kbit/s) and the DC voltage level (fieldbus supply voltage) is clearly keeping the limit values.</p>
	<p>PROFIBUS DP: No bus activity, open circuit voltage within correct range between 0.8 V and 1.4 V. The bus termination is correct, but no frames are transmitted on the bus. To run a test, you have to either switch on the PROFIBUS master or activate the master simulator.</p> <p>PROFIBUS PA: Either there is no activity on the bus or the DC voltage level is below the adjustable critical limit. Use the Bus Status function in order get more details about bus communication and DC voltage level.</p>
	<p>PROFIBUS DP: No bus activity, open circuit voltage below 0.8 V or above 1.4 V. If an open circuit voltage greater than 0 V is displayed in Bus Status function, the bus has not been properly terminated. An open circuit voltage of about 0.5 V to 0.6 V indicates that no power is supplied to one of the two bus terminations.</p> <p>PROFIBUS PA: The DC voltage level is either below the fixed error limit of 9 V or above the maximum allowable fixed error limit of 32 V. Use the Bus Status function in order get more details about bus communication and DC voltage level.</p>
	Master simulator is active. You can start the master simulator from the "Extras > Master simulator" menu.
	The BC-700-PB has detected the mounted PA-adapter BC-700-H1 and the license "PA Test" has been appropriately activated on the PROFIBUS Tester. The test system is ready to operate for testing PROFIBUS PA networks.

4.5 Menu functions

The following table gives a brief overview about the menu functions of BC-700-PB in stand-alone mode. The device help contains a more detailed description of operating functions (use the  softkey in the corresponding context).

The operating philosophy and the user interface for analyzing PROFIBUS DP- and PROFIBUS PA-networks are identical and thus, eliminating the need to learn the operating philosophy of an additional device. The PA-specific information will be explained in [*square brackets in italic type*].

Main menu	Submenu(s) (> Submenu function)	Short description
Test functions	Bus status > Overview	Bus Status function (Overview) assesses bus physics and bus communication and displays the test result in a simplified view.
	Bus status > Detail view	Bus Status function (Overview) assesses bus physics and bus communication and displays the test result in a simplified view.
	Signal quality [PA: Signal Level]	The signal quality [PA: signal level] test determines the signal quality index [PA: signal level] for each bus station and displays the test result in a bar diagram. The test location is particularly important when you are testing the signal quality [PA: signal level]. Additional information is available such as PROFIBUS DP: Signal/ Noise ratio, rise time and numerical values with respect to signal quality testing. PROFIBUS PA: Deviation of bitrate, signal polarity and numerical values with respect to signal level testing.
	Signal quality [PA: Signal Level] > Select test location	The test location is particularly important when you are testing the signal quality [PA: signal level]. We recommend performing at least two signal quality [PA: signal level] tests per physical segment (at both ends of the corresponding segment).
	Signal quality [PA: Signal Level] > Settings evaluation	The signal quality evaluation settings contain limit values for PROFIBUS DP: quality index, signal-to-noise ratio, rise time and timeout. PROFIBUS PA: DC voltage level and AC signal level
	Locate Stations > Select test location	Detects the topological order of the stations on the bus line by measuring the distances between masters and their related slaves. The measurement is purely passive and does not disturb a running system.
	Locate Stations > Delete location data	Allows to delete data from test locations.
	Oscilloscope	Using the Oscilloscope dialog you can analyze the waveform on the PROFIBUS cable.
	Cable test [PA: not available]	The cable test functionality examines the cabling in PROFIBUS segments. It detects the cable segment length, scans for unwanted reflections on the line and verifies proper termination of the cable. In case of a fault you will get an error description and a distance indication (if possible) for troubleshooting actions. You can only perform a cable test starting at one end of a PROFIBUS line; during the test no active stations (Master, MPI panel, ...) must be connected to the related cable segment. For further information and starting points in order to correctly interpret the fault indication see List of fault indications and remedial measures ⁴⁷ .

Main menu	Submenu(s) (> Submenu function)	Short description
	Cable test [PA: not available] > Edit Configuration	In the context of cable testing we recommend providing additional information about the corresponding cable segment (physical segment); this is important for proper detection of line length, compliance with maximum allowed segment length as well as for proper documentation of test results. Give full particulars with respect to the configuration of each cable segment.
	Cable test [PA: not available] > Cable Segment List	The cable segment list shows all segments which belong to the currently selected network in a tabular overview; an OK- or error-message is displayed (if available). Particularly in the context of acceptance control the commissioner can get a survey over the cabling of the network.
Recording Functions	Quick Test [PA: not available]	The Quick Test allows full testing of bus physics and bus communication. The test data is stored in the currently selected net (see submenu "Network Management") and can be imported by the PROFIBUS Diagnostics Suite software application. A progress label is displayed during the quick test. After completion of the test, a tabular overview is displayed which informs you about existing and missing quick tests respectively.
	Trend [PA: not available]	Trend logging is used for detecting rare or sporadic faults over a prolonged period of time. The function monitors both the bus physics and critical events in the bus communication. The test data is stored in the tool and can be imported by the PROFIBUS Diagnostics Suite software application. The tool displays the duration of the running trend test. After completion of the test, a tabular overview is displayed which informs you about existing and missing quick tests respectively. The Trend Test runs until it is manually stopped, ends when the power supply is interrupted or when the maximum logging time of 99 hours and 59 minutes is reached.
Network Management		You can easily create networks, segments and test locations in PROFIBUS Diagnostics Suite and then load this data onto your test tool. For more refer to the onlinehelp of PROFIBUS Diagnostics Suite in section "Preparation of tests".

Main menu	Submenu(s) (> Submenu function)	Short description
	Networks	Select network - The test tool stores the test results that are associated with a real PROFIBUS network in a separate file folder for that network. Three configurable directories are available. The radio button shows which network is currently selected. Each network contains at least one physical segment and test location.
	Networks > Edit Network	Segment list - The signals of stations located behind a repeater are regenerated and transmitted by the repeater. Therefore, all stations behind the same repeater will have identical test results. When using repeaters, you will thus have to test each segment separately. One test location belongs exclusively to one segment.
	Networks > Segment List > Edit Segment	Assign test locations to segments: Those test locations are particularly important which are located within the currently tested physical segment. We recommend performing at least two signal quality tests per physical segment (at both ends of the corresponding segment).
	Test Locations	Manage test locations: Particularly when testing signal quality, the test location has a major influence on the test result. To find these faults, it is recommended to measure the signal quality at different locations on the bus, at least at both line ends. If a PROFIBUS network comprises multiple segments connected through repeaters, you have to measure each segment separately.
Extras	Master simulator <i>[PA: not available]</i>	Using the master simulator, you can even test the signal quality while you are still setting up a PROFIBUS installation and the actual master (controller) is not operational yet. The master simulator is disabled by default when you switch on the tool. You can only select a baud rate on the display and thus start the master simulator if no other master is active. If you use the master simulator in a trend test, quick test recording or when running the Bus Status function, the values for the critical events will not be informative because the master simulator does not execute a regular DP protocol.
Settings	Energy Management	The energy management settings have a considerable bearing on battery life of the test device with respect to one battery charge. We recommend activating the automatic profile "economy".
	Language	Select language

Main menu	Submenu(s) (> Submenu function)	Short description
	Hardware Information	Hardware information is displayed here (version- and serial numbers).
	License	Displays license information

4.6 Organize and store test results

BC-700-PB comprises three predefined network folders: a default network folder and two empty folders.

A network folder is a directory containing all the test results assigned to a network. The name of the network folder is the same as the network name displayed during the data import into the PC.

The default network is provided for spontaneous tests and is a fixed component of the project management and cannot be deleted. However, you can rename and edit the default network and start testing using this network. If you are deleting all networks, automatically the default network including a default segment and a default test location will be generated in the network folder.

A network in BC-700-PB comprises one or more segments, and one or more test locations. A minimum network configuration (default network) comprises one segment (default segment) and one test location (default test location).

The test location has a major influence on the test result, particularly when testing signal quality, using the oscilloscope function or using the cable test function. To store all test results within a network in the BC-700-PB, you have to set the radio button to the corresponding network in the networks function (see also [User interface](#)³²).



Figure 28: Select Network – the radio button is set to "engine production"

Test results in stand-alone mode are stored under the specified test location in the network you have defined as the storage location. Thus, test results will be organized and stored in BC-700-PB according to their test location. Refer to the figure below to see an example network which could be organized as follows in BC-700-PB (recommendation):

1. Use the **Networks/ Select network** function and select an empty network folder. Enter the network name (e.g. "engine production").
2. Use the **Edit network** function and rename the default segment (e.g. to "heating") and add two new segments (e.g. "foundry" and "conveyor belt").
3. Use the **Test locations** function and generate six test locations.
4. Assign test location to segments. To do so, use the **Test locations** function or select **Networks → Edit Networks → Edit Segment**.

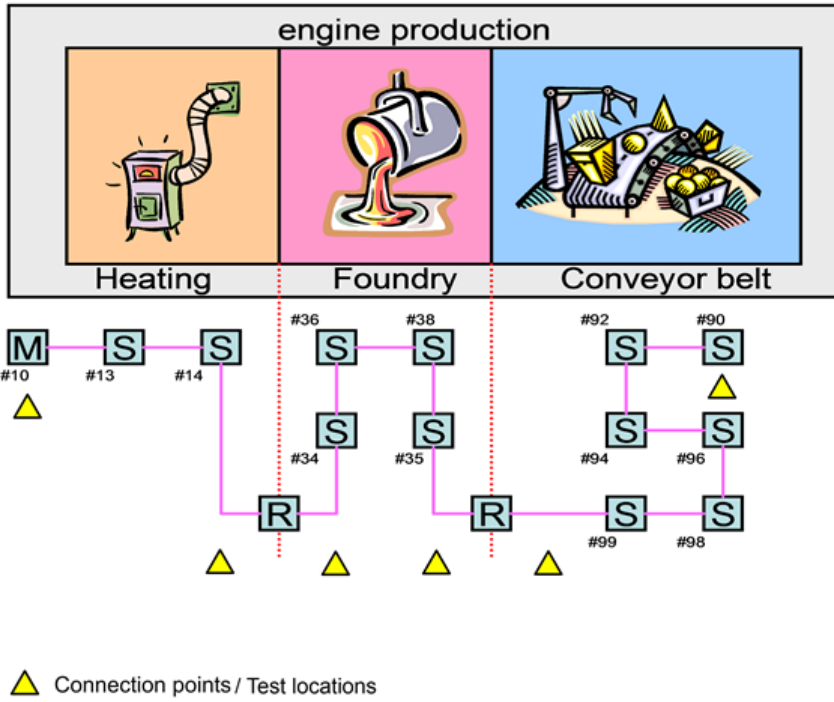

5 Data import into the PC

You can import quick tests, trend logs and cable test results from the test tool into the PC software. Proceed as follows:

1. Start the PROFIBUS Diagnostics Suite.
2. Connect the PROFIBUS Tester 5 (BC-700-PB). An additional Import Test Data dialog box appears automatically showing the test data previously saved:

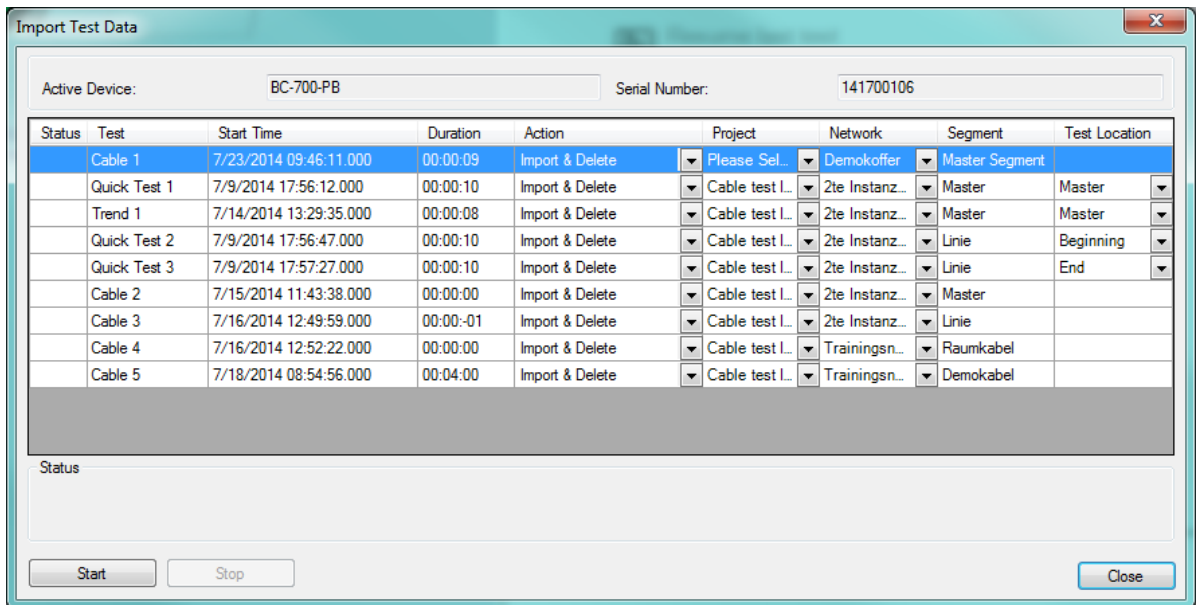

Figure 29: Importing test data

3. The **Import test data** dialog box has been filled in advance and contains already the network designations, segment designations and the test location designations, which have been derived from the network management of BC-700-PB.
4. For ALL the stored data, you need to fully select the action to be performed, the network/project and the test location to which you want to store the data. The default action "Import and Delete" deletes the test data in the tool after the import is completed. This frees the allocated memory locations for new tests.

The imported Quick Tests and Trend logs are fully compatible with the test data that can be acquired using the PC software.

6 Device management

6.1 Licenses

Some test functions of the BC-700-PB require activating a license.



Licenses are related to the serial number of your device and can only be used together with this device. Please include the serial number of your device when ordering a license.

If you already have licensed an option and you want to purchase an additional license please send your license key to Softing. This key contains both, the serial number and the license(s) already bought.

You can read the license key that is currently being used by the device from the License Manager (see [How to activate a license](#)⁴²). To do so select **Softing Interface**, the select tab **Interface Licenses**. The connected device together with its serial number and its license key is displayed. Copy the license key with a right mouse click and then insert it into a document.

6.1.1 Which license is activated?

Activated licenses are displayed in the BC-700-PB in menu **Settings** → **License**.

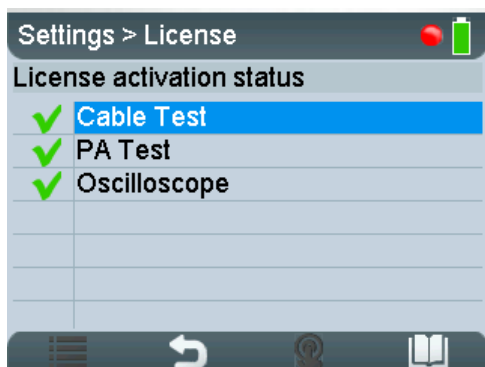

Disabled functions or functions without a license will be grayed out or are not visible in the main menu in stand-alone mode.



Hint

When USB is connected you can view the license activation status in PC-software PROFIBUS Diagnose Suite (**Help** → **Hardware Info**).

6.1.2 How to activate a license

- I. Install the PROFIBUS Diagnostics Suite (from your delivery CD-ROM or from the Softing download area in <http://industrial.softing.com/en/downloads.html>).
- II. Perform a firmware update:
 1. Connect the BC-700-PB with the USB cable to the PC and power on the test tool.
 2. Start the PROFIBUS Diagnostics Suite. The software verifies whether the firmware needs to be updated. If your firmware needs to be updated, a firmware update window appears. Click **[Automatic Update]**, to update the firmware.
 3. Close the PROFIBUS Diagnostics Suite after a successful firmware update.

III. Activate your license in BC-700-PB:

1. Connect the BC-700-PB with the USB cable to the PC and power on the test tool.
2. Start the License Manager with **Start → All Programs → Softing → License Manager → License Manager V4**.
3. The **Softing Interface** button in the left area must be activated. If it is deactivated, click the reload arrow () in the upper right corner.
4. Click the **Softing Interface** button. Then select tab **Interface Licenses**. the BC-700-PB and its serial number are displayed.
5. Enter the license key from the supplied certificate into the field License Key.
6. Click [**Enable license**]. The license acquired s now displayed in the information area.

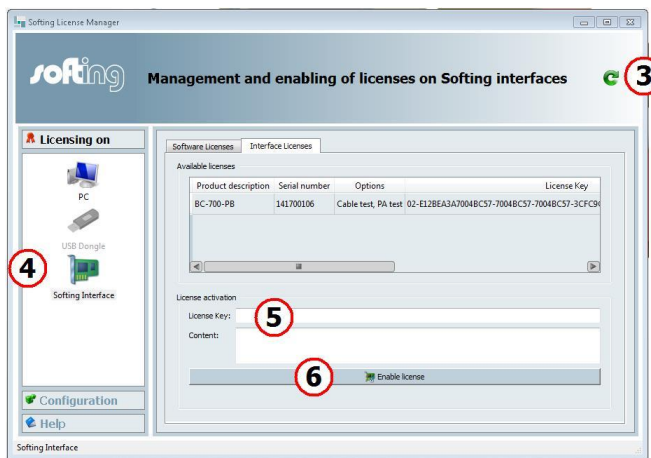

7. Close the Softing License Manager.

6.2 Firmware update

Firmware updates are made available as required. They are provided with the updates to the PC software on our website download area (<http://industrial.softing.com/en/downloads.html>) They allow access to new or improved functionality (see also [how to activate a license](#)⁴² or User Manual "PROFIBUS Diagnostics Suite - first steps".

7 Maintenance and Servicing

The BC-700-PB is maintenance-free. It should however be re-calibrated every 24 months. Repairs may only be carried out by the device manufacturer. All returns must be made without supplied carrying case and accessories (unless otherwise agreed). Please also include a brief fault description and a phone number at which we can contact you should we need further details. Please also include a brief fault description and a phone number at which we can contact you should we need further details. In case of returns within the warranty period, please also enclose a copy of the invoice or delivery note.

The built-in battery is subjected to normal wear and tear. The battery capacity decreases in the course of years; this is typical for specified normal operation. Exhaustive discharge and overcharge or exhaustive operation of the device in conjunction with very high or low temperatures will accelerate the battery aging process (refer to [Notes on battery use](#))⁵⁴.

8 Troubleshooting

Problem	Possible causes and remedies
<p>The display of the BC-700-PB remains blank.</p>	<p>Possible cause:</p> <ul style="list-style-type: none"> • The BC-700-PB always needs an additional external power supply or the internal battery is not installed. <p>Remedy:</p> <ul style="list-style-type: none"> • Use the supplied external AC adapter to connect the tool to the mains power supply. • Charge the built-in battery <p>Alternative cause:</p> <ul style="list-style-type: none"> • The tool is defective. • The rechargeable battery is defective. <p>Remedy:</p> <ul style="list-style-type: none"> • Return the tool to the manufacturer. • Replace the rechargeable battery.
<p>The display shows the error message "USB ERROR - Refer to manual or disconn. for stand-alone mode".</p>	<p>Possible cause:</p> <ul style="list-style-type: none"> • This error message can be caused by poor physical connection via USB (loose contact). <p>Remedy:</p> <ul style="list-style-type: none"> • Check the USB cable and connector. <p>Alternative cause:</p> <ul style="list-style-type: none"> • The device may be connected via external USB hub, notebook docking stations or USB 3.0 port which could evoke problems during driver installation. <p>Remedy:</p> <ul style="list-style-type: none"> • We recommend connecting the unit directly to a USB 2.0 port.
<p>The baud rate is not detected automatically on a live PROFIBUS.</p>	<p>Possible cause:</p> <ul style="list-style-type: none"> • Massive disturbances in the bus physics. <p>Remedy:</p> <ul style="list-style-type: none"> • Manually set the baud rate and repeat the test.
<p>A main menu function is grayed out or is not visible respectively</p>	<p>Possible cause:</p> <ul style="list-style-type: none"> • Missing license. • Outdated firmware version in use. <p>Remedy:</p> <ul style="list-style-type: none"> • Please check your bill of delivery if the license is included in your order. • Please download the latest firmware version.
<p>It is not possible to activate the sleep mode for energy saving</p>	<p>Possible cause:</p> <ul style="list-style-type: none"> • A test function is currently active. <p>Remedy:</p> <ul style="list-style-type: none"> • Stop running test functions before activating the sleep mode.

Problem	Possible causes and remedies
<p>After some minutes the display becomes dark</p>	<p>Possible cause:</p> <ul style="list-style-type: none"> • Backlight was switched off automatically in the context of energy saving settings. <p>Remedy:</p> <ul style="list-style-type: none"> • Press any push button or push the scroll wheel. <p>Alternative cause:</p> <ul style="list-style-type: none"> • The tool automatically entered the sleep mode/ powered off in the context of energy saving settings. <p>Remedy:</p> <ul style="list-style-type: none"> • Press the power key in order to power up the device.
<p>The device is running but does not react to any user input</p>	<p>Possible cause:</p> <ul style="list-style-type: none"> • The program has crashed. <p>Remedy:</p> <ul style="list-style-type: none"> • Press the power key for at least three seconds to turn off the device. • Interrupt the power supply. You may need to open head screws on the back of the device and remove the connecting plug of the rechargeable battery.
<p>After switching on the device, the splash screen persists and shows "Selftest failed! System halted"</p>	<p>Possible cause:</p> <ul style="list-style-type: none"> • Self-testing has identified faulty device components. <p>Remedy:</p> <ul style="list-style-type: none"> • Return the tool to the manufacturer. • Optional: Press the key combination [Softkey 1] + [Softkey 4] during switch-on of the device. Detailed information about self-testing is shown.

You can find support contact data on the cover sheet's back side of this document.

9 Tips and tricks for cable testing



Perform cable test in stand-alone mode without mains adapter connected

When using the cable test function we recommend removing the mains adapter and operating on the BC-700-PB by means of the built-in battery in stand-alone operation mode.

9.1 Assessment criteria

The cable test function examines the cabling in PROFIBUS DP segments and summarizes the test result in a single statement ("Ok" or "Error"). Amongst technical criteria with respect to the cabling the overall assessment incorporates additional criteria with respect to the workflow and to plant planning. Under certain conditions a user may not be able to successfully finish cable testing in a dedicated segment (e.g. at a very early installation phase of a facility, when there is no possibility to power the bus terminators). In such a case it is recommended adding a comment to the corresponding test report which clarifies the circumstances that lead to the negative cable test result. Not all errors will inevitably lead to downtimes or represent under the specific circumstances a severe error. At last, the commissioner or maintenance personnel decides, if a PROFIBUS-network is functioning properly or not. The corresponding person gets necessary information and recommendations by means of using appropriate PROFIBUS diagnostic tools. The table below contains assessment criteria which must be fulfilled in order to successfully complete the cable testing function.

Failed, if at least one of the following criteria is fulfilled	Passed, if all of the following criteria are fulfilled
Substantial troubleshooting effort was carried out unsuccessfully and there are still errors on the cabling	All cabling errors have been successfully eliminated
The corresponding PROFIBUS DP segment is still affected by reflections on the cable	The corresponding PROFIBUS DP cable segment is free of reflections
The user did not run through the tree steps of cable testing	The user has run through each of the three steps of cable testing successfully
Detection of the cable segment length fails	The cable segment length has been successfully detected
Bus termination is not as expected	The terminators at both ends of the cable segment are switched on and properly powered
The detected cable segment length exceeds the limit value specified by PI (PROFIBUS PROFINET International)	The baudrate (entered by user) and the detected cable segment length fit together according to PI recommendation (PROFIBUS PROFINET International)

9.2 Cable test - fault indications and remedial measures

The classifying text messages in the graphical user interface of BC-700-PB which describe the cabling errors are kept concisely. The table below lists possible cabling error messages and provides a detailed description of the discovered fault indications. The column on the right contains "remedial measures" and further starting points in order to correctly interpret and to repair the indicated fault.

The BC-700-PB uses amongst other methods impulse reflectometry for assessing the cabling and classifying and locating errors on the cable. Multiple cable errors, which exist simultaneously on the cable may result in an imprecise cable test result. The more the corrective repair of the cable is proceeding, the more precise the cable test results in the corresponding PROFIBUS cable segment will be.

Electromagnetic interferences may influence PROFIBUS cable testing in a negative manner because cable conductors may act like an antenna. Consider this aspect during cable testing and take care of proper functional earthing of your plant respectively. Existing high frequency noise voltage may negatively influence the BC-700-PB if operated by means of the external power supply. We recommend operating on the BC-700-PB by means of the built-in battery under the above mentioned prevailing conditions.

Cable testing error message displayed on BC-700-PB	Remedial measures - starting points for correctly interpreting and repairing the indicated fault
Break on line A	The green signal line of the PROFIBUS-cable is broken. Search for damage on the cable in the vicinity of the indicated error location. Fatigue breakage or a faultily assembled PROFIBUS-connector may cause this error. The green signal line typically is connected to Pin 8 of the PROFIBUS Sub-D type connector.
Break on line B	The red signal line of the PROFIBUS-cable is broken. Search for damage on the cable in the vicinity of the indicated error location. Fatigue breakage or a faultily assembled PROFIBUS-connector may cause this error. The red signal line typically is connected to Pin 3 of the PROFIBUS Sub-D type connector.
Break on shield	The shielding conductor is broken in the tested cable segment. Alternatively electromagnetic shielding is not applied for in a continuous manner. Search for damage on the cable in the vicinity of the indicated error location. Fatigue breakage or a faultily assembled PROFIBUS-connector may cause this error. In rare cases electromagnetic shielding may be disrupted intentionally in order to avoid electromagnetic interferences. Check this issue with the planning personnel of the PROFIBUS-facility.
Short circuit between A and B	There is an unusual low ohmic or capacitive resistance between signal lines A and B. Search for damage on the cable in the vicinity of the indicated error location. A severe crush of the cable or multiple unpowered bus terminators may cause this error. In addition search for illegal spur lines and check, if moisture penetrated the cabling or if the cabling is heavily soiled.
Short circuit between A and shield Short circuit between B and shield Short circuit between A, B and shield	There is an unusual low ohmic or capacitive resistance between the mentioned signal lines and conductors. Search for damage on the cable in the vicinity of the indicated error location. A severe crush of the cable or a faultily assembled PROFIBUS-connector may cause this error. In addition search for illegal spur lines and check, if moisture penetrated the cabling or if the cabling is heavily soiled.
Capacitive Load / Spur Line	There is an unusual capacitive load between signal lines A and B and the shield conductor. An illegal spur line or interference-suppression capacitors may cause this error. This is common usage with "over-compensated" or defective PROFIBUS-devices. Disconnect the devices in the vicinity of the indicated error location and repeat cable testing in order to narrow down the error cause.
Unknown error	The cable is still affected by unwanted reflections. Though it is not possible to classify the fault indication. Search for damage on the cable in the vicinity of the indicated error location and make sure the PROFIBUS-connectors are assembled correctly.

Cable testing error message displayed on BC-700-PB	Remedial measures - starting points for correctly interpreting and repairing the indicated fault
	Unwanted reflections may emerge from transitions between media and signal conductors which have different impedance values (e.g. two different cable types).
Sending pulse could not be detected. The cable is either too short or not connected.	Do not fall below the minimum cable length of 3 meters. The intended use of cable testing requires a cable with adequate length.
(Near-end) terminator switched on No reflections could be detected. Please remove terminators.	During the first of the three steps of cable testing the PROFIBUS Tester requires an open cable on both sides. However, the tester detected an ohmic resistance between the signal wires and the resistance value is in the range of bus terminators. Make sure, that every bus terminator on every PROFIBUS-connector is switched off or is deactivated. Check the dip-switch for switching on/off bus terminators for proper function.
Idle voltage too high	The ideal idle voltage between signal wires A and B of a cable segment, which is properly terminated on both sides is approximately 1.1 Volts. The PROFIBUS-Tester detected voltage values higher than 3 Volts between the signal wires A-B; A-Shield and/or B-Shield. These unwanted potential differences obstruct the cable testing function, the test results will become void and running leakage currents may damage the PROFIBUS-Tester. Take care of proper functional earthing of your plant. We recommend removing the mains adapter and to operate on the BC-700-PB by means of the built-in battery if you are receiving this error message. This will avoid damage caused by leakage currents. Take also into consideration that the error cause could be a defective RS-485 driver of a PROFIBUS-device. Troubleshooting EMC and earthing issues are a highly complex field of activity. Therefore we recommend asking service providers which are primarily specialized in troubleshooting the above mentioned issues.
Far-end / Near-end terminator not powered.	The corresponding bus terminator has been switched on, but the terminator is improperly powered by 5 V supply voltage, yet. During the cable testing the PROFIBUS Tester requires a properly terminated cable at the far end (2nd test step) or on both sides of the cable segment (3rd test step). A properly terminated cable segment consists of activated and powered bus terminators on both sides of the cable. Make sure that the corresponding PROFIBUS-device at the corresponding end of the cable segment is powered and that the activated bus terminator is properly plugged to a powered PROFIBUS-device.

Cable testing error message displayed on BC-700-PB	Remedial measures - starting points for correctly interpreting and repairing the indicated fault
No terminator detected	<p>There is neither an unpowered bus terminator nor there was detected a bus terminator at all in the respective cable segment.</p> <p>During the cable testing the PROFIBUS Tester requires a properly terminated cable at the far end (2nd test step) or on both sides of the cable segment (3rd test step).</p> <p>When using D-sub connection, activated bus terminators are only effective at the incoming connector of PROFIBUS-connectors. The incoming connector is marked with "IN", an incoming arrow or "A1/B1". In addition check for PROFIBUS-cables which have been connected by mistake to the outgoing connector.</p>
Far-end / Near-end terminator wrong or not adapted.	<p>The PROFIBUS Tester detects an ohmic resistance between the signal wires A and B, but the resistance value is not as expected in the range of a bus terminator.</p> <p>Make sure, that the bus terminator is properly powered and the PROFIBUS-connector has been properly powered. Take into consideration that multiple bus terminators may be switched on and that dip-switches for switching on/off bus terminators may be defective (due to aging and soiling).</p>
Line A and B interchanged	<p>The green and the red signal line are interchanged. Possible cause might be a PROFIBUS connector which is assembled improperly. Please bear in mind that after having two times interchanged line A and B, this error cannot be recognized anymore. Only when interchanging both lines for a third time, you may recognize the error.</p> <p>Typically, the tester will not return a measured distance. In order to localize the fault location we recommend shortening the respective cable segment step by step by switching on bus terminators within the cable segment. Repeat the cable test after each shortening procedure until the error is no longer reported. The last active bus terminator is the faulty one.</p>
Near end terminator was powered by internal 5 V power supply.	<p>This message is a note and not an error message. The cable test has been passed successfully. The bus terminating resistor has been switched on at the test location but is not powered via a PROFIBUS station. Possible causes are: The related cable end is not connected to an activated PROFIBUS station or the 5 V power supply of the related PROFIBUS station is defective. The PROFIBUS tester was able to supply the bus terminating resistor with its tester-internal 5 V power supply.</p>

9.3 Metering the cable segment length correctly

Directly after starting the cable test function you will see the actual segment configuration. In the context of cable testing it is recommended to provide the number of connectors and connected devices in the respective cable segment. The provided number of these elements should be as precise as possible in order to correctly detect cable segment length or the distance to the error. This chapter illustrates, how connectors and devices influence the detection of the cable length.

Connectors: Please specify, how many 12 MBit/s PROFIBUS-connectors exist in the respective cable segment and enter the number in the segment configuration. The series inductance within the 12 MBit/s PROFIBUS-connectors act like a delay element on the cable with respect to impulse reflectometry. Every connector corresponds to approx. 50 cm cable length.

Devices: Please specify, how many PROFIBUS devices are connected to the respective cable segment (Master, Slave, repeater; typ. not more than 32). The RS485-driver unit of each PROFIBUS-station acts like a RC-circuit (delay element) on the cable. In the context of impulse reflectometry this corresponds to additional 20 cm cable length per device.

Thus, the combination consisting of connector plus device corresponds to approx. 70 cm cable length.

Example: A cable segment has approx. 50 m effective cable length and contains 20 PROFIBUS devices, which are connected to the line by means of 12 MBit/s Sub-D type connectors. Without indicating the number of connectors and devices the PROFIBUS Tester 5 (BC-700-PB) will detect a total cable segment length of 64 meters, which corresponds to a systematic error of measurement of approx. 28 %. The more precise you enter the number of connectors and devices into the segment configuration, the more precise the length indication will be (cable segment length or distance to error).

The cable length detection is optimized for standard PROFIBUS cable type A. The detected cable segment length will show a methodical error in measurement, if you are using a fieldbus cable with deviating impedance value.

10 Quality index compatibility between BC-600-PB and BC-700-PB

10.1 What does the quality index indicate and how is the index determined?

The signal quality index of BC-600-PB or BC-700-PB does not represent a physical measure such as voltage (volt) or current (ampere). The signal quality index combines various criteria in an index value and assesses the quality of the PROFIBUS station's signal. Figuratively speaking, the quality index value corresponds to the height of a free rectangular area below the signal sequence of a transmitted bit value ("free" is to say: the signal does not strike the rectangle). The signal sequence corresponding to 3/8 of the bit time at the rising or falling edge are not considered. That is why an ideal, rectangular signal sequence corresponds to a very high signal quality index, whereas voltage undershoot, spikes and shallow edges will reduce the tested signal quality index, because the unaffected rectangular area below the signal sequence is reduced. Bad signal quality values are either caused by a low RS-485 signal level of tested stations or by disturbances of the signal sequence. Particularly when assessing disturbances, the bandwidth of your measuring channel has a major influence on the test result. The measuring channel is composed by the connecting cable and the analogue electronic circuit in the test device.

10.2 Why might the BC-700-PB display different quality indexes?

The BC-700-PB uses the same algorithm for computing the signal quality index as it was already used by PB-T2, PB-T3 and BC-600-PB (PROFIBUS Tester 4). In contrast to the previously named older test devices, the BC-700-PB comprises a measuring channel with a significantly higher input bandwidth. This measurement channel is both used for testing the signal quality index and for recording the oscilloscope signal sequence. That is why BC-700-PB accounts for high-frequency disturbances during signal quality testing. The test results of other test devices will not account for high-frequency disturbances, although these type of disturbances play a major role with respect to the functioning of PROFIBUS networks.

BC-700-PB takes advantage by using the same analog measuring channel for all test functions: Signal quality index, Signal-to-Noise ratio (S/N) and oscilloscope are based on the same measurement and therefore are more consistent. You can analyze the cause of a reduced S/N by means of the oscilloscope function. Additionally, using only one measurement channel reduces the capacitive load on the network under test and the power consumption is lower. Hence the battery lasts longer.

PROFIBUS networks, which are affected by high-frequency disturbances will show lower quality index values. In fact the lower signal quality index values represent reality, but the test results will prevent comparability to former test data, which you have generated using older test devices. If comparability of test data is a mandatory requirement, it is recommended conducting the comparative test by means of BC-600-PB.

11 Notes on external trigger input and output



The external trigger interface is for use in oscilloscope function. It is not related to logical trigger conditions used for frame recording during protocol analysis.

The trigger output is "low active" and allows for triggering an external oscilloscope according to the trigger conditions of the internal oscilloscope functionality (triggering on voltage level or address). Note that the hardware driver at trigger output causes a small delay of the trigger signal.

Select the trigger condition "external trigger" in the PROFIBUS Diagnostics Suite, if you want to use the trigger input (high-active) as trigger condition for the internal oscilloscope function. A rising edge at trigger input initiates recording the signal.

The LEDs "OUT" and "IN" of the terminal block serve as optical control.



Detail view:

External trigger
input/output

Figure 30: Terminal block of the BC-700-PB

12 Notes on battery use

12.1 General hints and warnings on rechargeable battery use



Read the following notes before using or charging your rechargeable battery pack.

Failure to read and follow the below instructions may result in fire, personal injury and damage to property if charged or used improperly.



CAUTION

The rechargeable battery pack contains < 2 g Lithium.

- Softing Industrial Automation GmbH, its distributors or retailers assume no liability for failures to comply with these warnings and safety guidelines.
- By purchasing this battery, the buyer assumes all risks associated with lithium batteries. If you do not agree with these conditions, return the battery immediately before use.
- Never charge batteries unattended. When charging the battery pack you should always remain in constant observation to monitor the charging process and react to potential problems that may occur.
- Only charge the lithium battery pack when installed in the device and by using the delivered external AC adapter.
- If at any time you witness a battery starting to “balloon” or swell up, discontinue charging process immediately, disconnect the battery and observe it in a safe place outside of any building or vehicle and away from any combustible material for approximately 15 minutes. A swell up may cause the battery to leak. The reaction with air may cause the chemicals to auto-ignition. This may result in fire.
- Avoid short circuits! Never place the cells on a conductive surface.
- Cable short circuits can cause fire! If you accidentally short the wires, the battery must be placed in a safe area for observation for approximately 15 minutes. Additionally, if a short occurs and contact is made with metal (such as rings on your hand), severe injuries may occur due to conductivity of electric current.
- A battery can still self-ignite even after 10 minutes.
- In the event of a crash, you must remove battery for observation and place in a safe open area away from any combustible material for approximately 30 minutes.
- Never store or charge battery pack inside your car in extreme temperatures. Extreme temperatures can self-ignite the battery. Keep in mind the maximum allowed storage temperature. Refer to [Storage and Transportation](#)⁵⁶.
- Use caution to avoid puncture of the cell. Puncture of cells may cause fire.
- You must not pull the wire leads when you carry or remove the battery from the device.
- In case of cells being damaged, do not use the battery anymore!
- Do not open the cells! Oxygen and lithium will heavily react with each other!
- If the electrolyte gets in contact with your skin or with our eyes, wash immediately with water and soap and seek medical advice.

- Defective lithium ion batteries may evaporate substances which are harmful to health! Never inhale!
- For proper disposal ask your local recycling center or return battery packs to Softing. Do not ship damaged battery packs. Contact our support department.
- Do not throw into fire!

12.2 Charge battery



CAUTION

Never charge batteries unattended.

Only charge on fire-proof surfaces.

Only use the wide-range power supply (AC adapter) provided with the tool (see [Delivery scope](#))¹⁰ in order to charge the battery. Set voltage and current correctly. Failure to do so can cause fire.



Follow the instructions from section [General hints and warnings on rechargeable battery use](#)⁵⁴.



The internal battery is NOT being charged when connected to a USB port.

If the BC-700-PB indicates a low charge, proceed as follows:

1. Connect the external AC adapter (standard accessory) to a wall outlet.
2. Connect the external AC adapter to the BC-700-PB.
3. The BC-700-PB will automatically start charging. The power key on top of the BC-700-PB is going to blink steadily during the charge process. The graphical display remains switched off. The device is fully charged if the power key flares up very shortly.

Alternatively you may power on the device in order to receive additional information about the charge process. The battery charge level indicator is located at the upper right corner of the screen:



the battery is being charged (white flash symbol).



the battery is fully charged - without mains charger connected.



the battery is fully charged - with mains charger connected.

4. You can disconnect the AC adapter from the device, then from the wall outlet. We recommend switching off the device in order to save energy.



Hint

You do not need to charge the battery for a specific length of time. You can use the device while it is charging.

12.3 Replace battery



Switch off device and disconnect charger

Always switch off the device and disconnect the charger before removing or installing the battery.

1. Take a screwdriver (Phillips) and open the head screws on the back side of the device.
2. Remove the back cover.

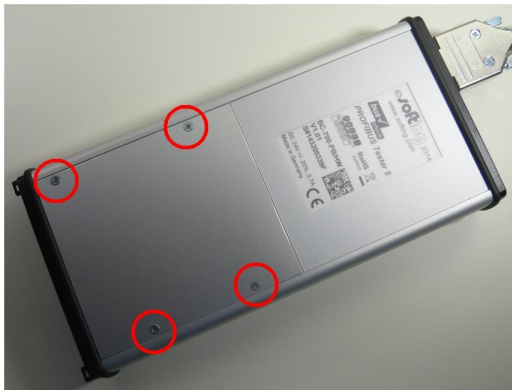

Figure 31: Removing the back cover of BC-700-PB

3. Remove the integrated battery. For disposal refer to section [Declarations by the manufacturer](#)⁵⁹.
4. Make sure that the provided battery is free of damage such as missing insulation of wire leads, puncture or deformation.
5. Insert the new battery. Connect the new battery. The connecting plug is protected against polarity reversal.
6. Check that the connecting plug is properly connected.
7. Mount the back cover and fix the screws.

12.4 Discharge battery

The energy management of the device complies with the following recommendations for discharging lithium ion batteries:

- Do not discharge the battery more than 80 % of nominal capacity.
- Do not discharge battery to a level below 3.5 V per cell without load. Deep discharge under load below 3.3 V per cell can deteriorate the battery.

Discharge operating temperature: see [Technical data](#)⁵⁸ (operating temperature).

12.5 Storage and transportation

Do not store the battery packs fully charged. If the battery is not used for more than one to two weeks, consider the following notes on storage:

- Store battery at 3.85V per cell (corresponds approx. 33% of the battery charge display, see [Device status](#)³⁴)
- Store at a temperature between 12°C/53F and 18°C/65F

- Do not expose battery pack to direct sunlight.
- Store in fireproof case or box.

**CAUTION**

Storing battery at temperatures greater than 77°C/170F for extended periods of time (more than 2 hours) may cause damage to battery and possible fire.

12.6 Battery lifetime

Charging and discharging will typically wear out the battery pack over the time. Due to this aging the usable battery capacity will decrease accordingly. Higher current loads and deep discharge processes will considerably increase the aging process.

You will have best results with respect to battery life, if you

- avoid deep discharging,
- charge the battery properly,
- store the battery at recommended temperatures,
- avoid overloading,
- switch off the device when not being used for a longer period of time.

12.7 Battery warranty

Misuse, abuse, incorrect charging and other inappropriate use of this product are not covered under warranty.

Product warranty is limited to original defects in material and workmanship of the original and unused battery pack!

12.8 Lithium backup battery

**CAUTION**

This product contains a lithium backup battery!

The lithium content is not more than 1 g. The battery has been successfully tested by the manufacturer in accordance with the UN Manual of Test and Criteria (test procedures of Part III, Sub-Section 38.3).

Improper handling of lithium batteries can cause the batteries to ignite or explode and pose a burn hazard to users. If the product is properly handled, this battery does not need to be replaced during the lifetime of the product. Therefore, opening the product is unnecessary and not permitted. The product must only be operated within the specified temperature range. Do not expose to heat above this temperature range and keep away from open fire. Store in a dry place.

13 Technical Data

Power supply/ battery	Via external AC adapter 110 V .. 240 VAC 50/60 Hz (galvanically isolated) or built-in three cells lithium ion accumulator with 11.1 VDC. The rechargeable battery has a run-time of up to 5 hours (run-time depends on the executed test functions and rate of wear of the rechargeable battery) Battery is charged via external AC adapter.
RS485 (DP)	<p>PROFIBUS D-sub connector (female), 9-pin, switchable power supply for ext. bus termination Bus termination</p> <p>Protocol and frame analysis: PROFIBUS DP and DPV1, automatic baud rate detection 9.6 kbit/s .. 12 Mbit/s</p> <p>Signal analysis: PROFIBUS DP, DPV1, FMS and MPI; signal quality index 0 .. 5000 determined from signal waveform as well as signal/noise ration and rise time; Signal sampling with 8/16 samples per bit</p> <p>Oscillogram display: test range ±5V at 10 mV resolution (differential), 0V...15V at 15mV resolution (A or B to DGND)</p> <p>Sampling rate up to 384 MSamples/s, for signal details: 2,400 sampled points, for oscillogram analysis 8,192 sampled points</p> <p>Topology scan: active, maximum distance 230 m, accuracy ±2 m</p> <p>Cable test: active, permitted cable segment length 5 m ... 1500 m, accuracy 5%</p>
USB	V 2.0, high speed 480 Mbit/s, galvanically isolated
Trigger	<p>IN: L=0 .. 0,8 V; H=2,4 .. 24 V; pulse > 10 µs, active high</p> <p>OUT: ca. 5 V, active low (connection to storage oscilloscope)</p>
Internal memory capacity	3 network directories for storing Quick Tests, cable tests and trend logs Trend logging max. 99 hours
Dimensions	HxWxD: 35 x 220 x 110 mm
Weight	Test tool without cable: approx. 0.75 kg, complete with carrying case, without accessories: approx. 4.2 kg
Protection class	IP 20
Permissible ambient conditions	<p>Operating temperature 0 ... 50 °C</p> <p>Storage temperature -20 ... 70 °C</p> <p>Air humidity 10 ... 90 % without condensation</p>
Conformity	CE, FCC, VCCI
Operation	<p>Via graphical color display, four function keys and scroll wheel including central push-button or via PC/notebook.</p> <p>Display languages available: German, English</p>
PC operating software	PROFIBUS Diagnostics Suite, see separate documentation

14 Declarations by the manufacturer

This device complies to the EU product directive 2004/108/EC according to the following directives:

Reference number	Description
EN 55011:2009 + A1:20102, Class A	Industrial, scientific and medical equipment - Radio-frequency disturbance characteristics - Limits and methods of measurement, class A
EN 55022:2010, Class A	Information technology equipment - Radio disturbance characteristics - Limits and methods of measurement, class A
EN 61000-6-2:2005	Electromagnetic compatibility (EMC) - Part 6-2: Generic standards - Immunity for industrial environments
EN 61000-6-4:2007 + A1:2011	Electromagnetic compatibility (EMC) - Part 6-4: Generic standards - Emission standard for industrial environments
EN 61326-1:2013	Electrical equipment for measurement, control and laboratory use - EMC requirements - Part 1: General requirements
EN 50581:2012	Technical documentation for the assessment of electrical and electronic products with respect to the restriction of hazardous substances



A Declaration of Conformity in compliance with the above standards has been made and can be requested from Softing Industrial Automation GmbH.



CAUTION

This is a Class A product. In a domestic environment this product may cause radio interference in which case the user may be required to take adequate measures!



ROHS

The PROFIBUS Tester 5 (BC-700-PB) device is ROHS compliant.



WEEE

Electrical and electronic equipment must be disposed of separately from normal waste at the end of its operational lifetime.



Please dispose of this product according to the respective national regulations or contractual agreements. If there are any further questions concerning the disposal of this product, contact Softing Industrial Automation.



Note

To fulfill the EMC requirements, the other components (AC adapter, PROFIBUS stations, etc.) also have to meet the EMC requirements. A shielded cable must be used. In addition, the cable shield must be grounded properly.



Note

Additional tests have been performed successfully proving compatibility with the requirements set forth by FCC and VCCI.

Index

- A -

Accessory
 optional ~ 11
 Activate
 License 42
 Activate license 42
 Activated licenses 42

- B -

Backup battery 57
 Battery
 charge 55
 discharging 56
 general hints 54
 notes on use 54
 replace 56
 spare ~ 13
 storage 56
 warnings 54
 warranty 57
 Battery charge level indicator 34

- C -

Cable structure
 for testing in PA networks 12
 Cable test
 assessment criteria 47
 fault indications 47
 remedial measures 47
 tips and tricks 47
 Carrying case
 Content 10
 Connection
 to bus 29
 Conventions used
 Buttons 7
 Menu commands 7
 Program code 7

- D -

Data
 technical ~ 58
 Delivery scope 10

D-sub adapter cable 11, 20
 D-sub connection 13

- F -

Fieldbus Shield Digital Leakage Current Clamp 11
 Firmware update 42, 43

- H -

H1 adapter 12

- I -

Import data 41
 Importing
 Data to PC 41

- L -

License Manager 42
 Live bus
 analyzing 27
 testing 20
 testing (DP) 23

- M -

M12 adapter set 11
 M12 connection 14
 Measurement status 34
 Menüs 35

- O -

Operation mode
 return to ~ 19

- P -

PA adapter 28
 Power down
 automatically 19
 manually 19

- Q -

Quality index 52

- R -

Related documents 7

- S -

Service interface 13

Sleep mode 19

Softkeys 34

Stand-alone mode 32

- T -

Test status 34



Trigger input 53

Troubleshooting 45

This page is intentionally left blank.

Softing Industrial Automation GmbH

Richard-Reitzner-Allee 6
85540 Haar / Germany
<http://industrial.softing.com>

 + 49 89 45 656-340
 + 49 89 45 656-488
 info.idn@softing.com

